



# FİYAT LİSTESİ

TERAZİLER & BASKÜLLER  
ENDÜSTRİYEL SİSTEMLER  
YÜK HÜCRELERİ  
İNDİKATÖRLER  
AKSESUARLAR

**Sirküler :** 2021 / 1

**Tarih :** 05.04.2021

**SATIŞ KOŞULLARI :**

Fiyatlara ayrıca %18 KDV ilave edilecek ve KDV peşin olarak tahsil edilecektir.  
Ödemeler 30 - 60 - 90 gün veya 60 günlük çek ile yapılacaktır  
Nakit ödemelerde % 5 iskonto uygulanacaktır.  
Zamanında yapılmayan ödemelere aylık % 5 vade farkı uygulanacaktır.  
Tüm fiyatlar fabrika teslim fiyatı olup, nakliye ve nakil taşıma sigortası ücreti alıcıya aittir.

**LABORATUAR TERAZİLERİ**

Model	Kod	Kapasite	Taksimat	Çözünürlük	FİYAT (TL)
<b>EGY</b> 	EGY-50	50 g	1 mg	1 / 50.000	<b>750,00</b>
	<b>YÜKSEK HASSASİYET LABORATUAR TERAZİSİ</b> <b>Özellikler</b> : Otomatik Kapanma, LCD Gösterge, Ekran Işığı Ağırlık Birimleri g, ct, oz, ozt, dwt, gn <b>Opsiyonlar</b> : RS-232 Bağlantısı <b>Kefe Ölçüleri</b> : $\phi$ 70 mm <b>Güç Kaynağı</b> : 4 adet AAA pil veya DC 6V-200mA				
<b>EHB</b> 	EHB-300	300 g	1 mg	1 / 300.000	<b>1.125,00</b>
	EHB-500	500 g		1 / 500.000	<b>1.390,00</b>
<b>YÜKSEK HASSASİYET LABORATUAR TERAZİSİ</b> <b>Özellikler</b> : Parça Sayma, Otomatik kapanma, LCD Gösterge ve Ekran Işığı, RS-232 Bağlantısı, Ağırlık Birimleri g, ct, oz, lb Altın Tartım Fonksiyonu <b>Kefe Ölçüleri</b> : $\phi$ 90 mm <b>Güç Kaynağı</b> : Adaptör					<b>CE</b>
<b>FGH</b> 	FGH-200	200 g	1 mg	1 / 200.000	<b>1.785,00</b>
	<b>YÜKSEK HASSASİYET LABORATUAR TERAZİSİ</b> <b>Özellikler</b> : Parça Sayma, Otomatik Kapanma, RS-232 Bağlantısı , LCD Gösterge Ekran Işığı, Birimler g, ct, oz, ozt, dwt, lb, gn, tola, dr, MM, tI.T, tI.J <b>Opsiyonlar</b> : Yazıcı <b>Kefe Ölçüleri</b> : $\phi$ 98 mm <b>Güç Kaynağı</b> : Akü veya Adaptör (10V-500mA)				
<b>HCT-HB</b> 	HCT-HB 220	220 g	1 mg	1 / 220.000	<b>1.600,00</b>
	HCT-HB 320	320 g	1 mg	1 / 320.000	<b>1.800,00</b>
<b>YÜKSEK HASSASİYET LABORATUAR TERAZİSİ</b> <b>Özellikler</b> : Parça Sayma, Yüzeleme, LCD Gösterge, Ekran Işığı, RS-232 Bağlantısı, g, ct, oz, dwt <b>Opsiyonlar</b> : Yazıcı <b>Kefe Ölçüleri</b> : $\phi$ 116 mm <b>Güç Kaynağı</b> : 12 V Adaptör .Akülü					<b>CE</b>

**HASSAS TARTIM TERAZİLERİ**

Model	Kod	Kapasite	Taksimat	Çözünürlük	FİYAT (TL)
<b>KD-TBC</b> 	KD-TBC 300	300 g	0,01 g	1 / 30.000	<b>625,00</b>
	KD-TBC 600	600 g	0,01 g	1 / 60.000	<b>695,00</b>
	KD-TBC 1200	1200 g	0,01 g	1 / 120.000	<b>910,00</b>
	<b>HASSAS TARTIM TERAZİSİ</b> <b>Özellikler</b> : Parça Sayma, Yüzdeleme LCD Gösterge, Ekran Işığı, RS-232 Bağlantısı <b>Opsiyonlar</b> : Arka Gösterge <b>Kefe Ölçüleri</b> : $\phi$ 116 mm (yuvarlak) 150 - 600g 145 x 125 mm (dörtgen) 1200 - 3000g <b>Güç Kaynağı</b> : Akü veya Adaptör				
<b>HCT-HB</b> 	HCT-HB 600	600 g	0,01 g	1 / 60.000	<b>695,00</b>
	HCT-HB 1200	1200 g	0,01 g	1 / 120.000	<b>910,00</b>
	HCT-HB 3000	3000 g	0,1 g	1 / 30.000	<b>695,00</b>
	<b>HASSAS TARTIM TERAZİSİ</b> <b>Özellikler</b> : Parça Sayma, Yüzdeleme, HOLD fonksiyonu, RS-232 Bağlantısı LCD Gösterge, Ekran Işığı, Birimler <b>Opsiyonlar</b> : Arka Gösterge <b>Kefe Ölçüleri</b> : $\phi$ 116 mm (yuvarlak) 150, 300, 600, 1200 g 158 x 158 mm (dörtgen) 3000, 6000 g <b>Güç Kaynağı</b> : Akü veya Adaptör				
<b>HT-SH</b> 	HT-SH 300	300 g	0,005 g	1 / 60.000	<b>1.070,00</b>
	HT-SH 600	600 g	0,01 g	1 / 60.000	
	HT-SH 1500	1500 g	0,02 g	1 / 60.000	
	<b>HASSAS TARTIM TERAZİSİ</b> <b>Özellikler</b> : Özgül Ağırlık Ölçme Programı (Altın Tartım), Parça Sayma, Yüzdeleme Oto Kapanma, LCD Gösterge, Ekran Işığı, RS-232 Bağlantısı <b>Opsiyonlar</b> : USB Bağlantısı <b>Kefe Ölçüleri</b> : $\phi$ 116 mm (yuvarlak) 300, 600g 144 x 124 mm (dörtgen) 1500, 3000g <b>Güç Kaynağı</b> : Akü veya Adaptör				
<b>KS-500</b> 	KS-500	500 g	0,01 g	1 / 50.000	<b>410,00</b>
	<b>HASSAS TARTIM TERAZİSİ</b> <b>Özellikler</b> : Hassas Tartım Terazisi, Otomatik Kapanma LCD Gösterge, Ekran Işığı, Ağırlık Birimleri <b>Opsiyonlar</b> : - <b>Kefe Ölçüleri</b> : $\phi$ 100 mm <b>Güç Kaynağı</b> : Pil veya Adaptör				

## HASSAS TARTIM TERAZİLERİ

Model	Kod	Kapasite	Taksimat	Çözünürlük	FİYAT (TL)
<b>EHB</b> 	EHB-1000	1 kg	0,01 g	1 / 100.000	<b>610,00</b>
	EHB-3000	3 kg	0,01 g	1 / 300.000	<b>790,00</b>
	<b>HASSAS TARTIM TERAZİSİ</b> <b>Özellikler</b> : Parça Sayma, Otomatik Kapanma, LCD Gösterge ve Ekran Işığı Özgül Ağırlık Ölçme (Altan Tartım Fonksiyonu), RS-232 Bağlantısı Ağırlık Birimleri g, ct, oz, lb <b>Kefe Ölçüleri</b> : $\phi$ 130 mm <b>Güç Kaynağı</b> : Akü veya Adaptör				
<b>EHB</b> 	EHB-5000	5 kg	0,01 g	1 / 500.000	<b>1.040,00</b>
	EHB-6000	6 kg	0,01 g	1 / 600.000	<b>1.100,00</b>
	<b>HASSAS TARTIM TERAZİSİ</b> <b>Özellikler</b> : Parça Sayma, Otomatik Kapanma, LCD Gösterge ve Ekran Işığı Özgül Ağırlık Ölçme (Altan Tartım Fonksiyonu), RS-232 Bağlantısı Ağırlık Birimleri g, ct, oz, lb <b>Kefe Ölçüleri</b> : 170 x 145 mm <b>Güç Kaynağı</b> : Akü veya Adaptör				
<b>DGH</b> 	DGH-2000	2 kg	0,01 g	1 / 200.000	<b>620,00</b>
	<b>HASSAS TARTIM TERAZİSİ</b> <b>Özellikler</b> : Parça Sayma, Otomatik Kapanma, LED Gösterge Ağırlık Birimleri g, ct, oz, lb <b>Kefe Ölçüleri</b> : 192 x 143 mm <b>Güç Kaynağı</b> : Akü veya Adaptör				
<b>FGH</b> 	FGH-3000	3 kg	0,01 g	1 / 300.000	<b>1.540,00</b>
	<b>HASSAS TARTIM TERAZİSİ</b> <b>Özellikler</b> : Parça Sayma, Otomatik Kapanma, RS-232 Bağlantısı , LCD Gösterge Ekran Işığı, Birimler g, ct, oz, ozt, dwt, lb, gn, tola, dr, MM, tl.T, tl.J <b>Opsiyonlar</b> : Özgül Ağırlık ölçülmesi için altadan tartım ilavesi <b>Kefe Ölçüleri</b> : $\phi$ 115 mm <b>Güç Kaynağı</b> : Akü veya Adaptör (10V-500mA)				

## ONAYLI HASSAS TARTIM TERAZİLERİ

Model	Kod	Kapasite	Taksimat	Çözünürlük	FİYAT (TL)
<b>HT-SA</b> 	<b>M</b> HT-SA-600	600 g	0,01 g	1 / 60.000	<b>1.545,00</b>
<b>HT-NA</b> 	<b>M</b> HT-NA-600	600 g	0,01 g	1 / 60.000	<b>1.715,00</b>
<b>HT-NA</b> 	<b>M</b> HT-NA-6000	6000 g	0,1 g	1 / 60.000	<b>1.750,00</b>
<b>HT-NH</b> 	HT-NH-300	300 g	0,005 g	1 / 60.000	<b>1.250,00</b>
	HT-NH-600	600 g	0,01 g	1 / 60.000	
	HT-NH-1500	1500 g	0,02 g	1 / 60.000	
	<b>HASSAS TARTIM TERAZİSİ</b> <b>Özellikler</b> : Parça Sayma, Yüzdeleme, Oto. Kapanma LCD Gösterge, Ekran Işığı, RS-232 Bağlantısı <b>Opsiyonlar</b> : USB Bağlantısı, Yazıcı (LP-50) <b>KeFe Ölçüleri</b> : $\phi$ 116 mm (yuvarlak) 300, 600g 144 x 124 mm (dörtgen) 1500, 3000g <b>Güç Kaynağı</b> : Akü veya Adaptör 				

**PASLANMAZ TARTIM TERAZİLERİ**

Model	Kod	Kapasite	Taksimat	Çözünürlük	FİYAT (TL)
<b>FSH</b> 	FSH-600	600 g	0,01 g	1 / 60.000	<b>1.250,00</b>  <b>PASLANMAZ HASSAS TERAZİ</b> <b>Özellikler</b> : Paslanmaz Gövdeli Hassas Tartım Terazisi LCD Gösterge, Ekran Işığı <b>Kefe Ölçüleri</b> : $\phi$ 98 mm <b>Güç Kaynağı</b> : Akü veya Adaptör  <b>CE</b>
<b>FR-EJ</b> 	FR-EJ-1	1 kg	0,1 g	1 / 10.000	<b>425,00</b>  <b>PASLANMAZ TERAZİ</b> <b>Özellikler</b> : Paslanmaz Gövdeli Tartım Terazisi LCD Gösterge, Ekran Işığı <b>Kefe Ölçüleri</b> : 145 x 140 mm <b>Güç Kaynağı</b> : Adaptor ve Pili (şarj edilebilir pil)  <b>CE</b>
	FR-EJ-5	5 kg	1 g	1 / 5.000	
<b>FEC</b> 	FEC-3	3 kg	0,1 g	1/ 30.000	<b>935,00</b>  <b>PASLANMAZ TERAZİ</b> <b>Özellikler</b> : Paslanmaz Gövdeli Hassas Tartım Terazisi LCD Gösterge, Ekran Işığı <b>Kefe Ölçüleri</b> : 165 x 175 mm <b>Güç Kaynağı</b> : Adaptor ve Pili (şarj edilebilir pil)  <b>CE</b>
	FEC-6	6 kg	0,2 g	1/ 30.000	
	FEC-10	10 kg	0,5 g	1/ 20.000	
<b>WPS</b> 	WPS-3	3 kg	0,1 g	1/ 30.000	<b>965,00</b>  <b>PASLANMAZ TERAZİ</b> <b>Özellikler</b> : Paslanmaz Gövdeli Tartım Terazisi LCD Gösterge, Ekran Işığı, Otomatik Kapanma <b>Opsiyonlar</b> : RS-232 Bağlantısı <b>Kefe Ölçüleri</b> : 210 x 160 mm <b>Güç Kaynağı</b> : Akülü  <b>CE</b>
	WPS-6	6 kg	0,2 g		
	WPS-15	15 kg	0,5 g		
	WPS-30	30 kg	1 g		

**PASLANMAZ TARTIM TERAZİLERİ**

Model	Kod	Kapasite	Taksimat	Çözünürlük	FİYAT (TL)
<b>SW</b> 	SW-6	6 kg	0,5g	1/ 15.000	1.190,00
	SW-15	15 kg	1 g		
	SW-30	30 kg	2 g		
	<b>PASLANMAZ TERAZİ</b> <b>Özellikler</b> : Paslanmaz Gövdeli Tartım Terazisi, IP-68 LED Gösterge, Alt-Üst Limitleme <b>Opsiyonlar</b> : RS-232 Bağlantısı <b>Kefe Ölçüleri</b> : 250 x 190 mm <b>Güç Kaynağı</b> : Akülü				
<b>AGS</b> 	AGS-6	6 kg	2 g	1 / 3.000	1.400,00
	AGS-15	15 kg	5 g		
	<b>TİCARİ ONAYLI - PASLANMAZ TERAZİ</b> <b>Özellikler</b> : Paslanmaz Gövdeli Tartım Terazisi LCD Gösterge, Ekran Işığı <b>Opsiyonlar</b> : RS-232 Bağlantısı, Yazıcı <b>Kefe Ölçüleri</b> : 210 x 210 mm <b>Güç Kaynağı</b> : Akülü				

## TARTIM TERAZİLERİ

Model	Kod	Kapasite	Taksimat	Çözünürlük	FİYAT (TL)
<b>FRJ</b> 	FRJ-05	5 kg	1 g	1 litrelik kab	<b>160,00</b>
	<b>TARTIM TERAZİSİ</b> <b>Özellikler</b> : Mutfak Terazisi, Otomatik Kapanma, Yuvarlak Çukur Kefe LCD Gösterge, Ekran Işığı, Ağırlık Birimi Seçenekleri <b>Opsiyonlar</b> : - <b>Kefe Ölçüleri</b> : 115 mm <b>Güç Kaynağı</b> : Pili (4 adet AAA pil) veya Adaptör				
<b>FKS</b> 	FKS-02	2 kg	0,1 g	1 / 20.000	<b>265,00</b>
	FKS-05	5 kg	0,5 g	1 / 10.000	<b>250,00</b>
	FKS-10	10 kg	1 g	1 / 10.000	<b>260,00</b>
<b>TARTIM TERAZİSİ</b> <b>Özellikler</b> : Tartım Terazisi, Otomatik Kapanma LCD Gösterge, Ekran Işığı <b>Opsiyonlar</b> : - <b>Kefe Ölçüleri</b> : 175 x 160 mm <b>Güç Kaynağı</b> : Pili (6 adet AA pil) veya Adaptör					<b>CE</b>
<b>KS</b> 	KS-03	3 kg	0,1 g	1 / 30.000	<b>300,00</b>
	KS-06	6 kg	1 g	1 / 6.000	<b>235,00</b>
<b>TARTIM TERAZİSİ</b> <b>Özellikler</b> : Mutfak Terazisi LCD Gösterge, Ekran Işığı <b>Opsiyonlar</b> : - <b>Kefe Ölçüleri</b> : 157 x 157 mm <b>Güç Kaynağı</b> : Pili ve Adaptör					<b>CE</b>
<b>MII</b> 	MII-600	600 g	0,1 g	1 / 6.000	<b>375,00</b>
	MII-3000	3000 g	0,5 g		
<b>TARTIM TERAZİSİ</b> <b>Özellikler</b> : Tartım Terazisi, LCD Gösterge, Ekran Işığı <b>Opsiyonlar</b> : - <b>Kefe Ölçüleri</b> : 200 x 130 mm <b>Güç Kaynağı</b> : Pili					<b>CE</b>





**TARTIM TERAZİLERİ**

Model	Kod	Kapasite	Taksimat	Çözünürlük	FİYAT (TL)
<b>DGH</b> 	DGH-5000	5 kg	0,1 g	1 / 50.000	<b>620,00</b>
	<b>TARTIM TERAZİSİ</b> Özellikler : Tartım Terazisi, Kırmızı LED Gösterge Kefe Ölçüleri : 195 x 140 mm Güç Kaynağı : Akülü				
<b>KD-KC</b> 	KD-KC-300	300 g	0,01 g	1/ 30 000	<b>600,00</b>
	KD-KC-600	600 g	0,01 g	1/ 60 000	<b>685,00</b>
	KD-KC-1000	1000 g	0,1 g	1/ 10 000	<b>370,00</b>
	KD-KC-6000	6000 g	0,5 g	1/ 12 000	<b>375,00</b>
	<b>TARTIM TERAZİSİ</b> Özellikler : Tartım Terazisi, Kefe üzerinde özel koruma kapağı LCD Gösterge, Ekran Işığı Kefe Ölçüleri : 142 x 128 mm Güç Kaynağı : Pili (6 adet AA pil)				
<b>G1</b> 	G1-15	15 kg	1 g	1 / 15.000	<b>585,00</b>
	G1-30	30 kg	2 g		
	G1-....-R	Ön ve Arka Göstergeli			<b>695,00</b>
<b>TARTIM TERAZİSİ</b> Özellikler : Tartım Terazisi, LCD Gösterge, Ekran Işığı, Oto. Kapanma Opsiyonlar : RS-232 Bağlantısı, Adaptör Kefe Ölçüleri : 250 x 210 mm Güç Kaynağı : <u>3 adet pil ile 4000 saat</u> ve USB kablo					
<b>ACS-Z</b> 	ACS-Z-3	3 kg	0,2 g	1 / 15.000	<b>415,00</b>
	ACS-Z-6	6 kg	0,5 g		
	ACS-Z-15	15 kg	1 g		
	ACS-Z-30	30 kg	2 g		
<b>TARTIM TERAZİSİ</b> Özellikler : Tartım Terazisi LCD Gösterge, Ekran Işığı Kefe Ölçüleri : 270 x 220 mm Güç Kaynağı : Akülü					

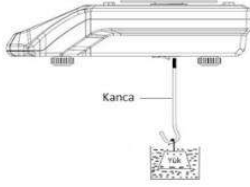

**TARTIM TERAZİLERİ**

Model	Kod	Kapasite	Taksimata	Çözünürlük	FİYAT (TL)
<b>QW</b>    <b>Alttan Tartım Fonksiyonu</b>  	QW-A	3 kg	0,5g / 1g	1 / 3.000 İki Kademeli  <b>M CE</b>	725,00
		6 kg	1 g / 2 g		
		15 kg	2 g / 5 g		
		30 kg	5 g / 10 g		
	QW-M	3 kg	0,1 g	1 / 30.000  <b>CE</b>	710,00
		6 kg	0,2 g		
		15 kg	0,5 g		
		30 kg	1 g		
	QW-H	3 kg	0,05 g	1 / 60.000  <b>CE</b>	845,00
		6 kg	0,1 g		
		15 kg	0,2 g		
		30 kg	0,5 g		
	QW-S	6 kg	0,05 g	1 / 150.000  <b>CE</b>	1.180,00
		15 kg	0,1 g		
		30 kg	0,2 g		
	QW-U	6 kg	0,02 g	1 / 300.000  <b>CE</b>	1.575,00
		30 kg	0,1 g		
			Arka Gösterge ilavesi		
		RS-232 ilavesi			115,00
<b>TARTIM TERAZİSİ</b>  <b>Özellikler</b> : Tartım Terazisi, LCD Gösterge, Ekran Işıđı, Alt-Üst Limitleme <b>Opsiyonlar</b> : RS-232 Bağlantısı, Yazıcı, Arka gösterge <b>Kefe Ölçüleri</b> : 250 x 220 mm <b>Güç Kaynađı</b> : Akülü  <b>Ticari Kullanım Onaylı;</b> A : Tartım Hassasiyeti 1/3.000  <b>Endüstriyel Amaçlı Kullanım;</b> M : Tartım Hassasiyeti 1/30.000 H : Tartım Hassasiyeti 1/60.000 S : Tartım Hassasiyeti 1/150.000 U : Tartım Hassasiyeti 1/300.000					

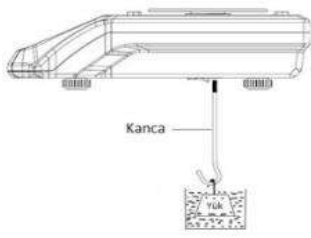
**TARTIM TERAZİLERİ**

Model	Kod	Kapasite	Taksimat	Çözünürlük	FİYAT (TL)
<b>CWT-22</b>  <b>Termal Yazıcı Opsiyonu</b>   <b>Altan Tartım Fonksiyonu</b> 	CWT-22-A	3 kg	0-1,5 kg x 0,5 g 1,5-3 kg x 1 g	1 / 3.000 <b>M CE</b>	<b>1.150,00</b>
		6 kg	0-3 kg x 1 g 3-6 kg x 2 g		
		15 kg	0-6 kg x 2 g 6-15 kg x 5 g		
		30 kg	0-15 kg x 5g 15-30 kg x10g		
		60 kg	0-30 kg x 10 g 30-60 kg x 20g		
	CWT-22-M	3 kg	0,1 g	1 / 30.000 <b>CE</b>	<b>1.120,00</b>
		6 kg	0,2 g		
		15 kg	0,5 g		
		30 kg	1 g		
		60 kg	2 g		
	CWT-22-H	3 kg	0,05 g	1 / 60.000 <b>CE</b>	<b>1.370,00</b>
		6 kg	0,1 g		
		15 kg	0,2 g		
		30 kg	0,5 g		
		60 kg	1 g		
CWT-22-S5	6 kg	0,05 g	1 / 150.000 <b>CE</b>	<b>1.745,00</b>	
	15 kg	0,1 g			
	30 kg	0,2 g			
CWT-22-U3	6 kg	0,02 g	1 / 300.000 <b>CE</b>	<b>2.025,00</b>	
	30 kg	0,1 g			
			Arka Gösterge ilavesi		<b>125,00</b>
			RS-232 ilavesi		<b>115,00</b>
<b>YÜKSEK HASSASİYETLİ TARTIM TERAZİSİ</b> <b>Özellikler</b> : Tartım Terazisi, LCD Gösterge ve Ekran Işığı Ticari Kullanım yada Endüstriyel Kullanım seçenekleri Örneklemeye ile Sayım, Alt-üst Limitleme, POS seçenekleri ve komut fonksiyonu (klavye kontrol) Alttan Tartım (Özgül Ağırlık Tartımı) <b>Opsiyonlar</b> : RS-232 Bağlantısı, Yazıcı <b>Kefe Ölçüleri</b> : 310 x 220 mm <b>Güç Kaynağı</b> : Akülü					

## TARTIM TERAZİLERİ

Model	Kod	Kapasite	Taksimat	Çözünürlük	FİYAT (TL)
<b>JS-B</b> 	JS-BM-03	3 kg	0,1 g	M 1 / 30.000	1.280,00
	JS-BM-06	6 kg	0,2 g		
	JS-BM-15	15 kg	0,5 g		
	JS-BM-30	30 kg	1 g		
	JS-BH-03	3 kg	0,05 g	H 1 / 60.000	1.485,00
	JS-BH-06	6 kg	0,1 g		
	JS-BH-15	15 kg	0,2 g		
	JS-BH-30	30 kg	0,5 g		
			RS-232 ilavesi		115,00
			Arka gösterge ilavesi		125,00
<b>TARTIM TERAZİSİ</b> <b>Özellikler</b> : Tartım Terazisi, Alttan Tartım (Özgül Ağırlık Tartımı), Yüzdeleme Örnekleme ile Sayma, Alt-Üst Limitleme, LCD Gösterge, Ekran Işığı <b>Opsiyonlar</b> : RS-232 Bağlantısı, Yazıcı, Röle Kutusu <b>Kefe Ölçüleri</b> : 300 x 230 mm <b>Güç Kaynağı</b> : Akülü					

Termal Yazıcı

Alttan Tartım

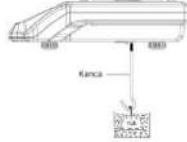

## ADW



ADW-6	6 kg	0,5 g	1 / 15.000	1.050,00
ADW serisine ikinci (arka gösterge ilavesi)				125,00
<b>SUYA KARŞI KORUMALI TARTIM TERAZİSİ</b> <b>Özellikler</b> : Tartım Terazisi, Alt-Üst Limitleme, Örnekleme ile Sayma LCD Gösterge, Ekran Işığı <b>Opsiyonlar</b> : RS-232 Bağlantısı, Yazıcı <b>Kefe Ölçüleri</b> : 250 x 215 mm <b>Güç Kaynağı</b> : Akülü				





## BW





BW-3	3 kg	0,2 g	1 / 15.000	985,00
BW-6	6 kg	0,5 g		
BW-15	15 kg	1 g		
BW-30	30 kg	2 g		
BW serisine ikinci (arka gösterge ilavesi)				125,00
<b>SUYA KARŞI KORUMALI TARTIM TERAZİSİ</b> IP-68 <b>Özellikler</b> : Tartım Terazisi, LED Gösterge <b>Opsiyonlar</b> : RS-232 Bağlantısı <b>Kefe Ölçüleri</b> : 210 x 175 mm <b>Güç Kaynağı</b> : Akülü				





**SAYICI TERAZİLER**

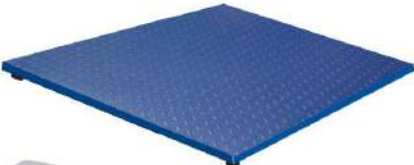





Model	Kod	Kapasite	Tartım	Sayım	FİYAT (TL)
<b>SEC</b> 	<b>SEC-06</b>	6 kg	0~3 kg = 1 g 3~6 kg = 2 g	0,1 g	<b>915,00</b>
	<b>SEC-15</b>	15 kg	0~6 kg = 2 g 6~15 kg = 5 g	0,2 g	
	<b>SEC-30</b>	30 kg	0~15 kg = 5 g 15~30 kg = 10 g	0,4 g	
<b>TİCARİ ONAYLI - SAYICI TERAZİ</b> <b>Özellikler</b> : Tartım Hassasiyeti 1/3.000 & Sayma Hassasiyeti 1/75.000 LCD Gösterge, Ekran Işığ, Hafıza <b>Opsiyonlar</b> : RS-232 Bağlantısı, Yazıcı <b>KeFe Ölçüleri</b> : 273 x 212 mm <b>Güç Kaynağı</b> : Akülü					
					

<b>SAC</b>  LP-50 Yazıcı Bağlantısı  	<b>SAC - 15</b>	15 kg	0,2 / 0,5 / 1 g	0,1 g	<b>1.400,00</b>
	<b>SAC - 30</b>	30 kg	0,5 / 1 / 2 g	0,2 g	
	<b>RS 232 ilavesi</b>				
<b>HASSAS SAYICI TERAZİ</b> <b>Özellikler</b> : Tartım Hassasiyeti 1/75.000 & Sayma Hassasiyeti 1/150.000 LCD Gösterge, Ekran Işığ, Hafızalı; 6 direkt tuş, Toplam 99 hafıza <b>Opsiyonlar</b> : RS-232 Bağlantısı, Yazıcı <b>KeFe Ölçüleri</b> : 345 x 230 mm (dörtgen) <b>Güç Kaynağı</b> : Akülü					
					

<b>SDC</b>  	<b>SDC - 06</b>	6 kg	0,5 g	0,1 g	<b>1.400,00</b>
	<b>SDC - 12</b>	12 kg	1 g	0,2 g	
	<b>SDC - 24</b>	24 kg	2 g	0,4 g	
<b>HASSAS SAYICI TERAZİ</b> <b>Özellikler</b> : Tartım Hassasiyeti 1/12.000 & Sayma Hassasiyeti 1/60.000 LCD Gösterge, Ekran Işığ, Hafızalı; 8 direkt tuş, <b>Opsiyonlar</b> : RS-232 Bağlantısı, Yazıcı <b>ÇİFT Platform bağlanabilme</b> <b>KeFe Ölçüleri</b> : 345 x 230 mm <b>Güç Kaynağı</b> : Akülü					
<b>İkinci Platform Kapasite Seçenekleri :</b>					
		<b>6 kg</b>	60 kg, 120 kg, 240 kg, 300 kg, 600 kg		
		<b>12 kg</b>	120 kg, 240 kg, 300 kg, 600 kg, 1200 kg		
		<b>24 kg</b>	240 kg, 300 kg, 600 kg, 1200 kg, 3000 kg		
					

## SAYICI TERAZİLER

Model	Kod	Kapasite	Tartım	Sayım	Hassasiyet	FİYAT (TL)
<b>JCS-A</b> 	JCSA-03	3 kg	0,1 g	0,025 g	1 / 30.000	415,00
	JCSA-06	6 kg	0,2 g	0,05 g		
	JCSA-15	15 kg	0,5 g	0,125 g		
	JCSA-30	30 kg	1 g	0,25 g		
<b>HASSAS SAYICI TERAZİ</b> <b>Özellikler</b> : Tartım Hassasiyeti 1/30.000 & Sayma Hassasiyeti 1/120.000 LCD Gösterge, Ekran Işığı <b>Opsiyonlar</b> : RS-232 Bağlantısı, Yazıcı <b>Kefe Ölçüleri</b> : 270 x 220 mm (dörtgen) <b>Güç Kaynağı</b> : Akülü 						



<b>QC</b> 	QC-A	3 kg	0,5g / 1g	0,5 g	1 / 3.000 	810,00
		6 kg	1 g / 2 g	0,1 g		
		15 kg	2 g / 5 g	0,2 g		
		30 kg	5 g / 10 g	0,4 g		
	QC-M	3 kg	0,1 g	0,025 g	1 / 30.000 	740,00
		6 kg	0,2 g	0,05 g		
		15 kg	0,5 g	0,125 g		
		30 kg	1 g	0,25 g		
	QC-H	3 kg	0,05 g	0,025 g	1 / 60.000 	875,00
		6 kg	0,1 g	0,05 g		
		15 kg	0,2 g	0,125 g		
		30 kg	0,5 g	0,25 g		
QC-S	6 kg	0,05 g	0,05 g	1 / 150.000 	1.235,00	
	15 kg	0,1 g	0,1 g			
	30 kg	0,2 g	0,2 g			
QC-U	6 kg	0,02 g	0,02 g	1 / 300.000 	1.535,00	
	30 kg	0,1 g	0,1 g			
<b>HASSAS SAYICI TERAZİ</b> <b>Özellikler</b> : Ticari Kullanım Onaylı; A : Tartım Hassasiyeti 1/3.000 & Sayma Hassasiyeti 1/75.000 Endüstriyel Amaçlı Kullanım; M : Tartım Hassasiyeti 1/30.000 & Sayma Hassasiyeti 1/100.000 H : Tartım Hassasiyeti 1/60.000 & Sayma Hassasiyeti 1/120.000 S : Tartım Hassasiyeti 1/150.000 & Sayma Hassasiyeti 1/150.000 U : Tartım Hassasiyeti 1/300.000 & Sayma Hassasiyeti 1/150.000 LCD Gösterge (Bölünmüş Display), Ekran Işığı <b>Opsiyonlar</b> : RS-232 Bağlantısı, Yazıcı <b>Kefe Ölçüleri</b> : 250 x 220 mm <b>Güç Kaynağı</b> : Akülü						

**SAYICI TERAZİLER**

Model	Kod	Kapasite	Tartım	Sayım		FİYAT (TL)
<b>HNC</b> 	HNC-M	3 kg	0,1 g	0,05 g	1 / 30.000	<b>850,00</b>
		6 kg	0,2 g	0,125 g		
		15 kg	0,5 g	0,25 g		
		30 kg	1 g	0,5 g		
	HNC-H	3 kg	0,05 g	0,02 g	1 / 60.000	<b>980,00</b>
		6 kg	0,1 g	0,05 g		
		15 kg	0,2 g	0,125 g		
		30 kg	0,5 g	0,25 g		
<b>HASSAS SAYICI TERAZİ</b> <b>Özellikler</b> : Tartım Hassasiyeti 1/30.000 & Sayma Hassasiyeti 1/100.000 LCD Gösterge, Ekran Işığı, Standart RS-232 Bağlantısı <b>Opsiyonlar</b> : Yazıcı <b>Kefe Ölçüleri</b> : 295 x 225 mm (dörtgen) <b>Güç Kaynağı</b> : Akülü						<b>CE</b>

<b>CCT</b>  	CCT-10-M	15 kg	0,5 g	0,2 g	1 / 30.000 <b>CE</b>	<b>1.070,00</b>
		30 kg	1 g	0,5 g		<b>1.200,00</b>
		60 kg	2 g	1 g		
	CCT-10-H	3 kg	0,05 g	0,02 g	1 / 60.000 <b>CE</b>	<b>1.260,00</b>
		6 kg	0,1 g	0,05 g		
		15 kg	0,2 g	0,1 g		
		30 kg	0,5 g	0,2 g		
	CCT-10-S5	60 kg	1 g	0,5 g		<b>1.450,00</b>
		6 kg	0,05 g	0,02 g	1 / 150.000 <b>CE</b>	<b>1.745,00</b>
		15 kg	0,1 g	0,05 g		
30 kg	0,2 g	0,1 g				
CCT-10-U3	6 kg	0,02 g	0,02 g	1 / 300.000 <b>CE</b>	<b>2.025,00</b>	
	30 kg	0,1 g	0,1 g			
RS 232 ilavesi						<b>115,00</b>
<b>HASSAS SAYICI TERAZİ</b> <b>Özellikler</b> : Tartım Hassasiyeti 1/300.000 & Sayma Hassasiyeti 1/300.000 LCD Gösterge, Ekran Işığı, Hafızalı <b>Opsiyonlar</b> : RS-232 Bağlantısı, Yazıcı <b>Kefe Ölçüleri</b> : 310 x 220 mm (dörtgen) <b>Güç Kaynağı</b> : Akülü						

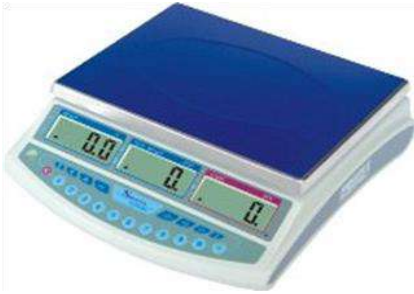
## SAYICI TERAZİLER

Model	Kod	Kapasite	Tartım	Sayım	FİYAT (TL)
<b>JS-A</b>   	<b>JS-AM</b>	3 kg	0,1 g	0,025 g	<b>1.660,00</b>
		6 kg	0,2 g	0,05 g	
		15 kg	0,5 g	0,125 g	
		30 kg	1 g	0,25 g	
		60 kg	2 g	0,5 g	
	<b>JS-AH</b>	3 kg	0,05 g	0,025 g	<b>1.800,00</b>
		6 kg	0,1 g	0,05 g	
		15 kg	0,2 g	0,125 g	
		30 kg	0,5 g	0,25 g	
		60 kg	1 g	0,5 g	
<b>RS-232 ilavesi</b>					<b>115,00</b>
<b>HASSAS SAYICI TERAZİ</b> <b>Özellikler</b> : Tartım Hassasiyeti 1/30.000 (JS-AM) & 1/60.000 (JS-AH) Sayma Hassasiyeti 1/120.000 LCD Gösterge, Ekran Işığı, Hi-Lo Kontrol <b>Opsiyonlar</b> : RS-232 Bağlantısı, LP-50 Yazıcı, 3 Işıklı Kolon <b>Kefe Ölçüleri</b> : 300 x 230 mm (dörtgen) <b>Güç Kaynağı</b> : Akülü					







<b>JS-AZ</b>  <b>İkinci Platform</b>   <b>Işıklı Kolon</b>  <b>Kontrol Kutusu</b>  <b>Yazıcı</b>	<b>JS - 03 AZH</b>	3 kg	0,05 g	0,025 g	<b>1.885,00</b>	
	<b>JS - 06 AZH</b>	6 kg	0,1 g	0,05 g		
	<b>JS - 15 AZH</b>	15 kg	0,2 g	0,125 g		
	<b>JS - 30 AZH</b>	30 kg	0,5 g	0,25 g		
	<b>JS - 60 AZH</b>	60 kg	1 g	0,5 g		
	<b>RS 232 ilavesi</b>					<b>115,00</b>
	<b>Kontrol Kutusu (Röle Çıkışları)</b>					<b>350,00</b>
	<b>3 Işıklı Kolon</b>					<b>420,00</b>
	<b>HASSAS SAYICI TERAZİ</b> <b>** İKİNCİ PLATFORM BAĞLANTILI</b> <b>Özellikler</b> : Tartım Hassasiyeti 1/60.000 & Sayma Hassasiyeti 1/120.000 LCD Gösterge ve 3 Farklı Renkte Ekran Işığı, Hi-Lo Kontrol Hafıza; Toplam 200 adet birim ağırlık hafızası <b>Opsiyonlar</b> : RS-232 Bağlantısı, 3 Işıklı Kolon, İkinci Platform LP-50 yazıcı (2 inç genişlik) GP3120 yazıcı (3 inç genişlik) <b>Kefe Ölçüleri</b> : 300 x 230 mm (dörtgen) <b>Güç Kaynağı</b> : Akülü					



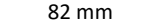
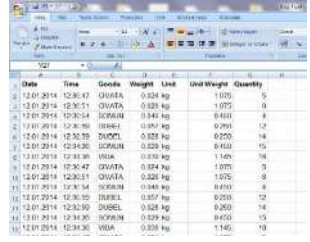

## SAYICI TERAZİLER

Model	Kod	Kapasite	Tartım	Sayım	FİYAT (TL)
<b>MCS</b> 	MCS-03	3 kg	0,1 g	0,025 g	<b>1.190,00</b>
	MCS-06	6 kg	0,2 g	0,05 g	
	MCS-15	15 kg	0,5 g	0,125 g	
	MCS-30	30 kg	1 g	0,25 g	
			Yazıcı 2 inç (58 mm) : LP-50		<b>\$240,00</b>
			Yazıcı 3 inç (82 mm) : GP3120N		<b>\$210,00</b>
<b>HASSAS SAYICI TERAZİ</b>					
<b>** ÜRÜN HAFIZALI</b>					
<b>Özellikler</b> : Tartım Hassasiyeti 1/30.000 & Sayma Hassasiyeti 1/100.000 LCD Gösterge ve Ekran Işığı RS-232 Bağlantısı ve USB Bağlantısı Hafıza; Toplam 2000 adet PLU ürün hafızası Rapor Alma ve Excel formatında listeleme fonksiyonu Ürün ismi, ürün no ve barkod gibi detayları etikete yazdırma					
<b>Opsiyonlar</b> : 58 mm veya 82 mm Yazıcı <b>Kefe Ölçüleri</b> : 275 x 220 mm (dörtgen) <b>Güç Kaynağı</b> : Akülü					
<b>Rapor Liste :</b>					
 					
 					
					
<b>CE</b>					



### Etiket Örneği :











58 mm



82 mm

Model	Kod	Kapasite	Tartım	Sayım	FİYAT (TL)
<b>RC-500</b> 	RC-500	20 kg	2 g	0,2 g	<b>3.800,00</b>
<b>BARKODLU HASSAS SAYICI TERAZİ</b>					
<b>Özellikler</b> : Grafik LCD Gösterge 100 mm x 100 mm (128 *128 Dots.) Parlak Ekran Işığı 2000 Adet Hafıza Çift yazıcı Dahili Termal Etiket Yazıcı İkinci Yazıcı ( Sürekli Kağıt - Fiş )					
Barkod Çeşitleri UPC ,ISBN,EAN-13,Code 39,Code 93 ,Cod 128B Code 128C ,interleaved 2/5 ,Code128RAW,CodeBar,MSI/PLESSY,PLS Etiket Yazıcısı Hızı : 80mm/sn Etiket Genişliği : 45-78 mm Etiket boyu : 25-200 mm					
<b>Opsiyonlar</b> : RS-232 Bağlantısı <b>Fiş Yazıcısı Hızı</b> : 80 mm/sn <b>Fiş genişliği</b> : 45-78 mm					
<b>Kefe Ölçüleri</b> : 360 x 265 mm (Dörtgen) <b>Güç Kaynağı</b> : Akülü					
<b>Etiket Örnekleri :</b>					
 					
<b>CE</b>					

## FİYAT HESAPLAMALI TERAZİLER

Model	Kod	Kapasite	Taksimat	Çözünürlük	FİYAT (TL)
<b>BEP</b> 	<b>BEP - 6</b>	6 kg	0-3 kg = 1 g 3-6 kg = 2 g	1 / 3.000 2 Kademeli Otomatik Taksimat	<b>750,00</b>
	<b>BEP - 15</b>	15 kg	0-6 kg = 2 g 6-15 kg = 5 g		
	<b>BEP - 30</b>	30 kg	0-15 kg = 5 g 15-30 kg = 10 g		
	<b>Çukur kefe ilavesi</b>				
<b>FİYAT HESAPLAMALI TARTIM TERAZİSİ</b> <b>Özellikler</b> : Fiyat Hesaplamalı, Hafızalı, İkili Otomatik Taksimat LCD Gösterge, Ekran Işığı <b>Opsiyonlar</b> : RS-232 Bağlantısı, Yazıcı <b>Kefe Ölçüleri</b> : 250 x 225 mm <b>Güç Kaynağı</b> : Pili					
					
<b>AQP</b> 	<b>AQP-6</b>	6 kg	0-3 kg = 1 g 3-6 kg = 2 g	1 / 3.000 2 Kademeli Otomatik Taksimat	<b>810,00</b>
	<b>AQP-15</b>	15 kg	0-6 kg = 2 g 6-15 kg = 5 g		
	<b>AQP-30</b>	30 kg	0-15 kg = 5 g 15-30 kg = 10 g		
	<b>Çukur kefe ilavesi</b>				
<b>FİYAT HESAPLAMALI TARTIM TERAZİSİ</b> <b>Özellikler</b> : Fiyat Hesaplamalı, İkili Otomatik Taksimat LCD Gösterge, Ekran Işığı <b>Opsiyonlar</b> : RS-232 Bağlantısı <b>Kefe Ölçüleri</b> : 250 x 220 mm <b>Güç Kaynağı</b> : Akülü					
					
<b>NP</b> 	<b>NP-15</b>	15 kg	0-6 kg = 2 g 6-15 kg = 5 g	1 / 3.000 2 Kademeli Otomatik Taksimat	<b>860,00</b>
	<b>NP-30</b>	30 kg	0-15 kg = 5 g 15-30 kg = 10 g		
	<b>Çukur kefe ilavesi</b>				
<b>FİYAT HESAPLAMALI TARTIM TERAZİSİ</b> <b>Özellikler</b> : Fiyat Hesaplamalı, Hafızalı, İkili Otomatik Taksimat LCD Gösterge, Ekran Işığı <b>Opsiyonlar</b> : RS-232 Bağlantısı <b>Kefe Ölçüleri</b> : 290 x 230 mm <b>Güç Kaynağı</b> : Akülü					
					
<b>SEP</b> 	<b>SEP - 15</b>	15 kg	0-6 kg = 2 g 6-15 kg = 5 g	1 / 3.000 2 Kademeli Otomatik Taksimat	<b>1.045,00</b>
	<b>SEP - 30</b>	30 kg	0-15 kg = 5 g 15-30 kg = 10 g		
	<b>Çukur kefe ilavesi</b>				
<b>FİYAT HESAPLAMALI TARTIM TERAZİSİ</b> <b>Özellikler</b> : Fiyat Hesaplamalı, Hafızalı, İkili Otomatik Taksimat LCD Gösterge, Ekran Işığı <b>Opsiyonlar</b> : RS-232 Bağlantısı, Yazıcı <b>Kefe Ölçüleri</b> : 250 x 225 mm <b>Güç Kaynağı</b> : Akülü					
					



## FİYAT HESAPLAMALI TERAZİLER

Model	Kod	Kapasite	Taksimat	Çözünürlük	FİYAT (TL)
<b>LP</b> 	LP-60	60 kg	0-30 kg = 10 g 30-60 kg = 20 g	1 / 3.000 2 Kademeli Otomatik Taksimat	<b>960,00</b>
	Çukur kefe ilavesi				
<b>FİYAT HESAPLAMALI TARTIM TERAZİSİ</b> <b>Özellikler</b> : Fiyat Hesaplamalı, Hafızalı, İkili Otomatik Taksimat LCD Gösterge, Ekran Işığı <b>Opsiyonlar</b> : RS-232 Bağlantısı <b>Kefe Ölçüleri</b> : 340 x 230 mm <b>Güç Kaynağı</b> : Akülü					
<b>M CE</b>					
<b>EQP</b> 	EQP - 60	60 kg	0-30 kg = 10 g 30-60 kg = 20 g	1 / 3.000 2 Kademeli Otomatik Taksimat	<b>1.520,00</b>
	EQP - 105	105 kg	0-60 kg = 20 g 60-105 kg = 50 g		<b>1.680,00</b>
	Çukur kefe ilavesi				
<b>FİYAT HESAPLAMALI TARTIM TERAZİSİ</b> <b>Özellikler</b> : Fiyat Hesaplamalı, Hafızalı, İkili Otomatik Taksimat LCD Gösterge, Ekran Işığı <b>Opsiyonlar</b> : RS-232 Bağlantısı, Yazıcı <b>Kefe Ölçüleri</b> : 300 x 260 mm <b>Güç Kaynağı</b> : Akülü					
<b>M CE</b>					
<b>WDP</b> 	WDP - 6	6 kg	0-3 kg = 1 g 3-6 kg = 2 g	1 / 3.000 2 Kademeli Otomatik Taksimat	<b>1.345,00</b>
	WDP - 15	15 kg	0-6 kg = 2 g 6-15 kg = 5 g		
	WDP - 30	30 kg	0-15 kg = 5 g 15-30 kg = 10 g		
	Çukur kefe ilavesi				
<b>FİYAT HESAPLAMALI TARTIM TERAZİSİ - SUYA KARŞI KORUMALI</b> <b>Özellikler</b> : Fiyat Hesaplamalı, Hafızalı, İkili Otomatik Taksimat Suya Karşı Korumalı Gövde, LCD Gösterge, Ekran Işığı <b>Opsiyonlar</b> : RS-232 Bağlantısı, Yazıcı <b>Kefe Ölçüleri</b> : 250 x 225 mm <b>Güç Kaynağı</b> : Akülü					
<b>M CE</b>					

## FİYAT HESAPLAMALI TERAZİLER

Model	Kod	Kapasite	Taksimat	Çözünürlük	FİYAT (TL)
<b>NPL</b> 	<b>NPL-15</b>	15 kg	0-6 kg = 2 g 6-15 kg = 5 g	1 / 3.000 2 Kademeli Otomatik Taksimat	<b>935,00</b>
	<b>NPL-30</b>	30 kg	0-15 kg = 5 g 15-30 kg = 10 g		
	<b>BOYUNLU - FİYAT HESAPLAMALI TARTIM TERAZİSİ</b> <b>Özellikler</b> : Boyunlu Terazi, Fiyat Hesaplamalı, Hafızalı LCD Gösterge, Ekran Işığ, <b>Opsiyonlar</b> : RS-232 Bağlantısı, <b>Kefe Ölçüleri</b> : 290 x 230 mm <b>Güç Kaynağı</b> : Akülü				
<b>LPL</b> 	<b>LPL-15</b>	15 kg	0-6 kg = 2 g 6-15 kg = 5 g	1 / 3.000 2 Kademeli Otomatik Taksimat	<b>995,00</b>
	<b>LPL-30</b>	30 kg	0-15 kg = 5 g 15-30 kg = 10 g		
	<b>FİYAT HESAPLAMALI TARTIM TERAZİSİ</b> <b>Özellikler</b> : Fiyat Hesaplamalı, Hafızalı, İkili Otomatik Taksimat LCD Gösterge, Ekran Işığ <b>Opsiyonlar</b> : RS-232 Bağlantısı <b>Kefe Ölçüleri</b> : 340 x 230 mm <b>Güç Kaynağı</b> : Akülü				
<b>SEPL</b> 	<b>SEPL-15</b>	15 kg	0-6 kg = 2 g 6-15 kg = 5 g	1 / 3.000 2 Kademeli Otomatik Taksimat	<b>1.190,00</b>
	<b>SEPL-30</b>	30 kg	0-15 kg = 5 g 15-30 kg = 10 g		
	<b>BOYUNLU - FİYAT HESAPLAMALI TARTIM TERAZİSİ</b> <b>Özellikler</b> : Boyunlu Terazi, Fiyat Hesaplamalı, Toplam 99 Hafıza, 4 Direkt Tuş LCD Gösterge, Ekran Işığ, 2 Kademeli Otomatik Taksimat <b>Opsiyonlar</b> : RS-232 Bağlantısı, Yazıcı <b>Kefe Ölçüleri</b> : 250 x 225 mm <b>Güç Kaynağı</b> : Akülü				
<b>CPTL</b> 	<b>CPTL-15</b>	15 kg	0-6 kg = 2 g 6-15 kg = 5 g	1 / 3.000 2 Kademeli Otomatik Taksimat	<b>1.235,00</b>
	<b>CPTL-30</b>	30 kg	0-15 kg = 5 g 15-30 kg = 10 g		
	<b>BOYUNLU - FİYAT HESAPLAMALI TARTIM TERAZİSİ</b> <b>Özellikler</b> : Boyunlu Terazi, Fiyat Hesaplamalı, İkili Otomatik Taksimat LCD Gösterge, Ekran Işığ <b>Opsiyonlar</b> : RS-232 Bağlantısı, LP-50 yazıcı <b>Kefe Ölçüleri</b> : 315 x 220 mm <b>Güç Kaynağı</b> : Akülü				

**KATLANIR BOYUNLU FİYAT HESAPLAMALI TERAZİLER**

Model	Kod	Kapasite	Taksimat	Tabla (cm)	FİYAT (TL)
<b>OPR</b> 	OPR - RSK	30 kg 60 kg 150 kg	5 g / 10 g 10 g / 20 g 20 g / 50 g	35 x 40	1.345,00
	OPR - RSK-SX				2.225,00
<b>BOYUNLU - FİYAT HESAPLAMALI TARTIM TERAZİSİ</b> <b>Özellikler</b> : Boyunlu Terazi, Fiyat Hesaplamalı, Hafızalı, İkili Taksimat Ön ve Arka LCD Gösterge, Ekran Işığı <b>Opsiyonlar</b> : RS-232 Bağlantısı, Yazıcı <b>Kefe Ölçüleri</b> : 35 x 40 cm <b>Güç Kaynağı</b> : Akülü					
					

<b>OPN</b> 	OPN - WYSK	30 kg 60 kg 150 kg	5 g / 10 g 10 g / 20 g 20 g / 50 g	35 x 40	1.700,00
	OPN - WSK				1.840,00
<b>BOYUNLU - FİYAT HESAPLAMALI TARTIM TERAZİSİ</b> <b>Özellikler</b> : Boyunlu Terazi, Fiyat Hesaplamalı, Toplam 99 Hafıza ( 42 Direk Tuş) Ön ve Arka LCD Gösterge, Ekran Işığı, İkili Taksimat <b>Opsiyonlar</b> : RS-232 Bağlantısı, Yazıcı <b>Kefe Ölçüleri</b> : 35 x 40 cm <b>Güç Kaynağı</b> : Akülü					
					





## BARKODLU SİSTEM TERAZİLERİ

Model	Kod	Kapasite	Taksimat	Detay	FİYAT (\$)
<b>RA serisi</b>  	RA-12-15	15 kg	2g / 5g	boyunsuz	\$ 550
	RA-12-30	30 kg	5g / 10g		
	RA-22-15	15 kg	2g / 5g	boyunlu	\$ 570
	RA-22-30	30 kg	5g / 10g		
<p><b>FİŞ YAZICILI ve FİYAT HESAPLAMALI TARTIM TERAZİSİ</b></p> <p><b>Özellikler</b> : Dahili Yazıcı, Fiyat Hesaplamalı Terazi, Termal Kağıt Fiş Yazdırır 4.3 inç LCD Gösterge (Grafik Ekran), Toplam 10000 PLU Hafıza, 42 adet direk hafıza tuşu, RJ-11, RJ-45, USB ve RS-232 Bağlantısı</p> <p><b>Opsiyonlar</b> : RFID, GPRS, Wifi, Zigbee</p> <p><b>Kefe Ölçüleri</b> : 342 x 242 mm</p> <p><b>Güç Kaynağı</b> : Akülü (Opsiyonel)</p> <div style="display: flex; justify-content: space-around; align-items: center;"> <div style="text-align: center;">   <b>AKÜLÜ</b> </div> <div style="text-align: center;">             Akıllı Telefon ile kumanda         </div> <div style="text-align: center;">  </div> </div> <div style="text-align: right;">  </div>					

<b>RB serisi</b>  	RB12-15	15 kg	2g / 5g	Boyunsuz Model	\$ 730
	RB12-30	30 kg	5g / 10g		
	RB22-15	15 kg	2g / 5g	Boyunlu Model	\$ 750
	RB22-30	30 kg	5g / 10g		
<p><b>BARKODLU TERAZİ</b></p> <p><b>Özellikler</b> : Çok fonksiyonlu Barkodlu Etiket veren Sistem Terazisi 5 inç Geniş LCD Ekran , RS-232, USB ve Ethernet Bağlantısı İkili Otomatik Taksimat , Bilgisayar Programı, Termal Etiket Yazdırır, Serbest Etiket Format Tasarımı 63 direk hafıza, 10.000 PLU Toplam Hafıza</p> <p><b>Opsiyonlar</b> : Wi-Fi, GPRS, Zigbee, CDMA</p> <p><b>Kefe Ölçüleri</b> : 380 x 295 mm (Dörtgen)</p> <div style="display: flex; justify-content: center; align-items: center;"> <div style="text-align: center;">  5 inç LCD ekran         </div> <div style="text-align: center;">  RFID okuyucu         </div> <div style="text-align: center;">  Kırsızız iletişim opsiyonu         </div> </div> <div style="display: flex; justify-content: center; align-items: center; margin-top: 10px;"> <div style="text-align: center;">  Ayarlanabilir mekanik bağlantısı         </div> <div style="text-align: center;">  Kolay ve pratik etiket yükleme         </div> </div> <div style="text-align: right;">  </div>					

**BARKODLU SİSTEM TERAZİLERİ**

Model	Kod	Kapasite	Taksimat	Detay	FİYAT (\$)
<b>TM-A</b> 	TM-A-15	15 kg	0-6 kg = 2 g 6-15 kg = 5 g	Boyunsuz Model	\$ 440
	TM-A-30	30 kg	0-15 kg = 5 g 15-30 kg = 10 g		
	TM-A-15	15 kg	0-6 kg = 2 g 6-15 kg = 5 g	Boyunlu Model	\$ 490
	TM-A-30	30 kg	0-15 kg = 5 g 15-30 kg = 10 g		
<b>BARKODLU TERAZİ</b> <b>Özellikler</b> : LCD Gösterge , Işıklı, RS-232, USB ve Ethernet Bağlantısı İkili Otomatik Taksimat , Bilgisayar Programı 2 X 63 = 126 direk hafıza , 6000 PLU Toplam Hafıza Rapor Alma Özelliği Etiket veya Fiş yazdırabilir <b>Opsiyonlar</b> : Kablosuz Bağlantı <b>Kefe Ölçüleri</b> : 350 x 260  					

<b>STL</b>  	STL - 15	15 kg	0-6 kg = 2 g 6-15 kg = 5 g	Boyunsuz Model	\$ 730
	STL - 30	30 kg	0-15 kg = 5 g 15-30 kg = 10 g		
	STL - 15-P	15 kg	0-6 kg = 2 g 6-15 kg = 5 g	Boyunlu Model	\$ 750
	STL - 30-P	30 kg	0-15 kg = 5 g 15-30 kg = 10 g		
<b>BARKODLU TERAZİ</b> <b>Özellikler</b> : LCD Gösterge , Işıklı, Akülü, RS-232 ve USB Bağlantısı İkili Otomatik Taksimat , Bilgisayar Programı 2 X 56 = 112 direk hafıza , 8000 PLU Toplam Hafıza Rapor Alma Özelliği Etiket veya Fiş yazdırabilir <b>Opsiyonlar</b> : Kablosuz Bağlantı <b>Kefe Ölçüleri</b> : 385 x 300  					

**MOBİL BASKÜLLER**

Model	Kapasite	Taksimat	Çözünürlük	Tabla	Tip	FİYAT (TL)		
<b>MS-HCW</b> 	60 kg	10 g	N	30 x 40 cm	E B CE	725,00		
	150 kg	20 g						
	60 kg	5 g	L	30 x 40 cm		785,00		
	150 kg	10 g						
	60 kg	10 g	N	40 x 50 cm		860,00		
	150 kg	20 g						
	60 kg	5 g	L	40 x 50 cm		925,00		
	150 kg	10 g						
	150 kg	20 g	N	50 x 60 cm		1.045,00		
	300 kg	20 g	L			1.095,00		
	<b>MİNİ TARTIM BASKÜLÜ</b> <b>Özellikler</b> : Taşınabilir Mini Tartım Baskülü, LCD gösterge ve ekran ışığı, Hold Fonksiyonu, Otomatik Kapanma <b>Opsiyon</b> : RS 232 ve Bluetooth bağlantıları <b>Güç Kaynağı</b> : Akülü ve Adaptörlü							

<b>FCS-A</b> 	<b>FCS-A-150</b>	150 kg	50 g	32,5 x 31,5 x 5,5 cm	475,00
	<b>FCS-A-200</b>	200 kg	100 g		
	<b>MİNİ TARTIM BASKÜLÜ</b> <b>Özellikler</b> : Tartım Baskülü, İnce Platform LCD Gösterge, Ekran Işığı, Hold Fonksiyonu, Otomatik Kapanma <b>Opsiyonlar</b> : RS-232 Bağlantısı <b>Güç Kaynağı</b> : PİL veya Adaptör CE				

<b>FCS-C</b> 	<b>FCS-C-300</b>	300 kg	100 g	35,5 x 40 x 5 cm	560,00
	<b>MİNİ TARTIM BASKÜLÜ</b> <b>Özellikler</b> : Tartım Baskülü, İnce Platform ( 5 cm yükseklik ) LCD Gösterge, Ekran Işığı, Hold Fonksiyonu, Otomatik Kapanma <b>Opsiyonlar</b> : RS-232 Bağlantısı <b>Güç Kaynağı</b> : Akülü CE				



**MOBİL BASKÜLLER**

Model	Kapasite	Taksimat	Çözünürlük	Tabla Ölçüleri	Tip			FİYAT (TL)	
<b>MS-RAW</b>  E tipi  U tipi 	60 kg	10/20 g	A	30 x 40 cm	E	B	M CE	810,00	
	150 kg	20/50 g						810,00	
	60 kg	10/20 g		40 x 50 cm				920,00	
	150 kg	20/50 g						1.045,00	
	300 kg	50/100 g		50 x 60 cm				1.225,00	
	150 kg	20/50 g						1.525,00	
	300 kg	50/100 g	60 x 70 cm	1.525,00					
	60 kg	10/20 g	A	30 x 40 cm	U	B	M CE	895,00	
	150 kg	20/50 g						895,00	
	60 kg	10/20 g		40 x 50 cm				1.025,00	
	150 kg	20/50 g						1.025,00	
	300 kg	50/100 g						1.025,00	
	60 kg	5 g	L	30 x 40 cm	U	B	CE	880,00	
	150 kg	10 g	M					930,00	
	60 kg	2 g	L	40 x 50 cm				1.095,00	
	150 kg	5 g						1.095,00	
	300 kg	20 g						1.095,00	
	60 kg	2 g	M					40 x 50 cm	1.135,00
150 kg	5 g	1.135,00							
300 kg	10 g	1.135,00							
300 kg	20 g	L	50 x 60 cm	E				B	1.150,00

**MINİ TARTIM BASKÜLÜ**

**Özellikler** : Mobil Tartım Baskülü, Kolay Taşınabilir Tasarım, Örnekleme ile sayma, (Hi-Low) ALT-Üst limitleme, Ağırlık kontrolü, LCD gösterge, Ekran ışığı (U tiplerinde : istenildiğinde indikatörü uzağa konulabilen )

Platform Tipleri ; E : Ekonomik Model  
U : Standart model

**Opsiyonlar** : RS-232 Bağlantısı

**Güç Kaynağı** : Akülü ve Adaptörlü

## FİYAT LİSTESİ

www.dikomsan.com

			
Boyut	Tip	Cins	Kapasiteler

MASAÜSTÜ BASKÜLLER						
--------------------	--	--	--	--	--	--

30 kg x 5 g 60 kg x 10 g 150 kg x 20 g	30 kg x 2 g 60 kg x 5 g 150 kg x 10 g	30 kg x 5 g 60 kg x 10 g 150 kg x 20 g	30 kg x 2 g 60 kg x 5 g 150 kg x 10 g	30 kg x 2 g 60 kg x 5 g 150 kg x 10 g	30 kg x 1 g 60 kg x 2 g 150 kg x 5 g	30 kg x 0,5 g 60 kg x 1g 150 kg x 2 g
1 / 6.000	1/15.000	1 / 6.000	1/15.000	1/15.000	1 / 30.000	1 / 60.000
<b>HCT-EL</b>		<b>HCT-CL</b>		<b>EW CW RAW</b>		
		<b>HCW</b>				
N	L	N	L	L	M	H

30 x 40 cm	LAR	S	30 kg...150 kg
------------	-----	---	----------------

1.015,00	1.030,00	1.070,00	1.085,00	1.175,00	1.200,00	1.315,00
----------	----------	----------	----------	----------	----------	----------

35 x 26 cm	D	B	30 kg...60 kg
		S	
		SX	

945,00	960,00	1.000,00	1.015,00	1.105,00	1.130,00	1.245,00
1.015,00	1.030,00	1.070,00	1.085,00	1.175,00	1.200,00	1.315,00
1.275,00	1.290,00	1.330,00	1.345,00	1.435,00	1.460,00	1.575,00

35 x 30 cm	D	SX	30 kg...60 kg
	DL		

1.230,00	1.245,00	1.285,00	1.300,00	1.390,00	1.415,00	1.530,00
1.415,00	1.430,00	1.470,00	1.485,00	1.575,00	1.600,00	1.715,00

35 x 40 cm	E	B1	30 kg...150 kg
		B2	
		SPS	
		SX	
	D	B	
		SPS	
		SX	
	W	B	
		YS	

815,00	830,00	870,00	885,00	975,00	-	-
825,00	840,00	880,00	895,00	985,00	-	-
1.185,00	1.200,00	1.240,00	1.255,00	1.345,00	-	-
1.720,00	1.735,00	1.775,00	1.790,00	1.880,00	-	-
995,00	1.010,00	1.050,00	1.065,00	1.155,00	1.225,00	1.405,00
1.250,00	1.265,00	1.305,00	1.320,00	1.410,00	1.480,00	1.660,00
1.785,00	1.800,00	1.840,00	1.855,00	1.945,00	2.015,00	2.195,00
1.245,00	1.260,00	1.300,00	1.315,00	1.405,00	1.475,00	1.655,00
1.595,00	1.610,00	1.650,00	1.665,00	1.755,00	1.825,00	2.005,00

35 x 45 cm	UR	SBS	30 kg...150kg
		SPS	

935,00	950,00	990,00	1.005,00	1.095,00	1.165,00	1.345,00
1.175,00	1.190,00	1.230,00	1.245,00	1.335,00	1.405,00	1.585,00

42 x 33 cm	D	B	30 kg...150 kg
		S	
		SX	

990,00	1.005,00	1.045,00	1.060,00	1.150,00	1.220,00	1.400,00
1.255,00	1.270,00	1.310,00	1.325,00	1.415,00	1.485,00	1.665,00
1.400,00	1.415,00	1.455,00	1.470,00	1.560,00	1.630,00	1.810,00

45 x 35 cm	UR	SBS	30 kg...150kg
		SPS	

935,00	950,00	990,00	1.005,00	1.095,00	1.165,00	1.345,00
1.175,00	1.190,00	1.230,00	1.245,00	1.335,00	1.405,00	1.585,00

**HCT-EL**



**HCT-CL**



**HCW**



**CW**



**EW**



**RAW**



35x40 EB1  
kısa boyun  
kısa siperlik



35x40 EB2  
uzun boyun  
uzun siperlik



35x40 HB-2c  
Sac Siperlik

32 x 24 K



35 x 26 DB



35 x 26 SX  
42 x 33 SX



35x40 WBK  
35x40 WYSK

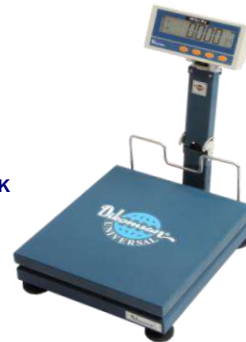

				TARTIM BASKÜLLERİ						
				60 kg x 10 g 150 kg x 20 g 300 kg x 50g	60 kg x 5 g 150 kg x 10 g 300 kg x 20 g	60 kg x 10 g 150 kg x 20 g 300 kg x 50g	60 kg x 5 g 150 kg x 10 g 300 kg x 20 g	60 kg x 5 g 150 kg x 10 g 300 kg x 20 g	60 kg x 2 g 150 kg x 5 g 300 kg x 10 g	60 kg x 1 g 150 kg x 2 g 300 kg x 5 g
				HCT-EL		HCT-CL HCW DW		CW EW RAW		
Boyut	Tip	Cins	Kapasiteler	N	L	N	L	L	M	H
40 x 50 cm	E	B	60kg....150 kg	900,00	915,00	955,00	970,00	1.060,00	-	-
		SPS		1.490,00	1.505,00	1.545,00	1.560,00	1.650,00	-	-
		SX		2.035,00	2.050,00	2.090,00	2.105,00	2.195,00	-	-
	D	B		1.120,00	1.135,00	1.175,00	1.190,00	1.280,00	1.350,00	1.530,00
		SPS		1.715,00	1.730,00	1.770,00	1.785,00	1.875,00	1.945,00	2.125,00
		SX		2.425,00	2.440,00	2.480,00	2.495,00	2.585,00	2.655,00	2.835,00
42 x 52 cm	U	SBS	60 kg....300 kg	1.575,00	1.590,00	1.630,00	1.645,00	1.735,00	1.805,00	-
		SPS		1.725,00	1.740,00	1.780,00	1.795,00	1.885,00	1.955,00	-
45 x 60 cm	U	SBS	60 kg....300 kg	1.630,00	1.645,00	1.685,00	1.700,00	1.790,00	1.860,00	-
		SPS		1.720,00	1.735,00	1.775,00	1.790,00	1.880,00	1.950,00	-
50 x 60 cm	E	B	60kg....300 kg	1.070,00	1.085,00	1.125,00	1.140,00	1.230,00	-	-
		SPS		1.615,00	1.630,00	1.670,00	1.685,00	1.775,00	-	-
		SX		2.315,00	2.330,00	2.370,00	2.385,00	2.475,00	-	-
	D	B		1.195,00	1.210,00	1.250,00	1.265,00	1.355,00	1.425,00	-
		SPS		1.745,00	1.760,00	1.800,00	1.815,00	1.905,00	1.975,00	-
		SX		2.705,00	2.720,00	2.760,00	2.775,00	2.865,00	2.935,00	-
60 x 70 cm	E	B	60 kg....300 kg	1.285,00	1.300,00	1.340,00	1.355,00	1.445,00	-	-
		B		1.480,00	1.495,00	1.535,00	1.550,00	1.640,00	1.710,00	-
	SPS	2.645,00		2.660,00	2.700,00	2.715,00	2.805,00	2.875,00	-	
70 x 80 cm	E	B	60kg....600 kg	1.505,00	1.520,00	1.560,00	1.575,00	1.665,00	1.735,00	-
		B		1.605,00	1.620,00	1.660,00	1.675,00	1.765,00	1.835,00	-
	SPS	2.900,00		2.915,00	2.955,00	2.970,00	3.060,00	3.130,00	-	
80 x 90 cm	E	B	60kg....600 kg	1.595,00	1.610,00	1.650,00	1.665,00	1.745,00	1.825,00	-
		B		1.670,00	1.685,00	1.725,00	1.740,00	1.820,00	1.900,00	-
	SPS	3.560,00		3.575,00	3.615,00	3.630,00	3.720,00	3.790,00	-	

## Opsiyonlar :



RS-232 Bağlantısı için

110,00

TL fiyata ilave edilir; (modeller EW, CW, RAW )



Bluetooth Bağlantısı için

210,00

TL fiyata ilave edilir; (modeller RAW )

**EW**



**CW**



**RAW**



**HCT-EL**



**HCT-CL**



**DW**



# FİYAT LİSTESİ

05.04.2021  
www.dikomsan.com

			
Boyut	Tip	Cins	Kapasiteler

30 x 40 cm	LAR	S	30 kg....150 kg
------------	-----	---	-----------------

35 x 26 cm	D	B	30 kg.....60 kg
		S	
		SX	

35 x 40 cm	E	B1	30 kg....150 kg
		B2	
		BK	
		SPS	
		SX	
	D	B	
		SPS	
		SX	

35 x 45 cm 45 x 35 cm	U	SBS	30 kg...150kg
		SPS	

42 x 33 cm	D	B	30 kg....150 kg
		S	
		SX	

40 x 50 cm	E	B	60 kg ...300 kg
		SPS	
		SX	
	D	B	
		SX	

50 x 60 cm	E	B	60kg.....150 kg
		SX	
	D	B	
		SPS	
		SX	

60 x 70 cm	E	B	60 kg....300 kg
	D	B	
		SPS	

70 x 80 cm	E	B	60kg.....600 kg
	D	B	
		SPS	

80 x 90 cm	E	B	60kg.....600 kg
	D	B	
		SPS	

## TİCARİ ONAYLI - TARTIM BASKÜLLERİ M

60 kg x 10 / 20 g 150 kg x 20 / 50 g 300 kg x 50 / 100g	60 kg x 10 / 20 g 150 kg x 20 / 50 g 300 kg x 50 / 100g	60 kg x 20 g 150 kg x 50 g 300 kg x 100g	60 kg x 20 g 150 kg x 50 g 300 kg x 100g	60 kg x 10 / 20 g 150 kg x 20 / 50 g 300 kg x 50 / 100g
---	---	--	--	---

RAW	RCW	APM	ABM	SEW-IN-R
-----	-----	-----	-----	----------

A				
---	--	--	--	--

1.175,00	1.390,00	-	1.805,00	1.670,00
----------	----------	---	----------	----------

1.105,00	1.320,00	-	1.735,00	1.600,00
----------	----------	---	----------	----------

1.175,00	1.390,00	-	1.805,00	1.670,00
----------	----------	---	----------	----------

1.435,00	1.650,00	-	2.065,00	1.930,00
----------	----------	---	----------	----------

975,00	1.190,00	-	1.605,00	1.470,00
--------	----------	---	----------	----------

985,00	1.200,00	-	1.615,00	1.480,00
--------	----------	---	----------	----------

1.115,00	1.330,00	-	1.745,00	1.610,00
----------	----------	---	----------	----------

1.345,00	1.560,00	-	1.975,00	1.840,00
----------	----------	---	----------	----------

1.880,00	2.095,00	-	2.510,00	2.375,00
----------	----------	---	----------	----------

1.155,00	1.370,00	1.410,00	1.785,00	1.650,00
----------	----------	----------	----------	----------

1.410,00	1.625,00	1.665,00	2.040,00	1.905,00
----------	----------	----------	----------	----------

1.945,00	2.160,00	2.200,00	2.575,00	2.440,00
----------	----------	----------	----------	----------

1.095,00	1.310,00	-	1.725,00	1.590,00
----------	----------	---	----------	----------

1.335,00	1.550,00	-	1.965,00	1.830,00
----------	----------	---	----------	----------

1.150,00	1.365,00	-	1.780,00	1.645,00
----------	----------	---	----------	----------

1.415,00	1.630,00	-	2.045,00	1.910,00
----------	----------	---	----------	----------

1.560,00	1.775,00	-	2.190,00	2.055,00
----------	----------	---	----------	----------

1.060,00	1.275,00	-	1.690,00	1.555,00
----------	----------	---	----------	----------

1.570,00	1.785,00	-	2.200,00	2.065,00
----------	----------	---	----------	----------

2.195,00	2.410,00	-	2.825,00	2.690,00
----------	----------	---	----------	----------

1.280,00	1.495,00	1.535,00	1.910,00	1.775,00
----------	----------	----------	----------	----------

2.585,00	2.800,00	2.840,00	3.215,00	3.080,00
----------	----------	----------	----------	----------

1.200,00	1.445,00	-	1.860,00	1.725,00
----------	----------	---	----------	----------

2.475,00	2.690,00	-	3.105,00	2.970,00
----------	----------	---	----------	----------

1.355,00	1.570,00	1.610,00	1.985,00	1.850,00
----------	----------	----------	----------	----------

1.905,00	2.120,00	2.160,00	2.535,00	2.400,00
----------	----------	----------	----------	----------

2.865,00	3.080,00	3.120,00	3.495,00	3.360,00
----------	----------	----------	----------	----------

1.445,00	1.640,00	-	2.075,00	1.940,00
----------	----------	---	----------	----------

1.640,00	1.835,00	-	2.270,00	2.135,00
----------	----------	---	----------	----------

2.805,00	3.020,00	-	3.435,00	3.300,00
----------	----------	---	----------	----------

1.665,00	1.860,00	-	2.295,00	2.160,00
----------	----------	---	----------	----------

1.765,00	1.960,00	-	2.395,00	2.260,00
----------	----------	---	----------	----------

3.060,00	3.275,00	-	3.690,00	3.555,00
----------	----------	---	----------	----------

1.755,00	1.950,00	-	2.365,00	2.250,00
----------	----------	---	----------	----------

1.830,00	2.025,00	-	2.440,00	2.325,00
----------	----------	---	----------	----------

3.720,00	3.935,00	-	4.350,00	4.215,00
----------	----------	---	----------	----------

**RAW****RCW****REW****SEW-IN****APM****ABM**

35 x 40 HB

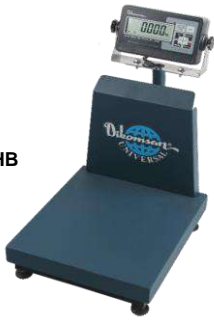

35 x 26 HB

D platform  
(Profil  
Siperlik)

45 x 60



46 x 60

**Opsiyonlar :**

RS-232 Bağlantısı için 110 TL + KDV fiyata ilave edilir; modeller RAW, RCW, REW, ABM, AFM18



Bluetooth Bağlantısı için 210 TL + KDV fiyata ilave edilir; modeller RAW, RCW, REW, ABM



30 x 40 cm	LAR	S	30 kg.....60 kg
------------	-----	---	-----------------

35 x 26 cm	D	B	30 kg.....60 kg
		S	
		SX	

35 x 40 cm	D	B	
		SPS	
		SX	

35 x 45 cm 45 x 35 cm	UR	SBS	30 kg.....150 kg
		SPS	

40 x 50 cm	D	B	30 kg.....300 kg
		SPS	
		SX	
	UR	SPS	

42 x 33 cm	D	B	30 kg.....150 kg
		S	
		SX	

42 x 52 cm	LUR	SBS	60 kg..300 kg
		SPS	

50 x 60 cm	D	B	60kg.....300 kg
		SPS	
		SX	

60 x 45 cm	UR	SBS	60kg.....300 kg
		SPS	

60 x 70 cm	E	B	60 kg.....300 kg
	D	B	
		SPS	

70 x 80 cm	E	B	60kg.....600 kg
	D	B	
		SPS	

80 x 90 cm	E	B	60kg.....600 kg
	D	B	
		SPS	

**HASSAS TARTIM BASKÜLLERİ**

60 kg x 2 g 150 kg x 5 g 300 kg x 10 g 600 kg x 20 g	60 kg x 1 g 150 kg x 2 g 300 kg x 5 g 600 kg x 10 g	100 kg x 1 g 200 kg x 2 g 500 kg x 5 g	120 kg x 1 g 240 kg x 2 g 600 kg x 5 g	150 kg x 1 g 300 kg x 2 g 600 kg x 5 g	30 kg x 0,1 g
1 / 30.000	1 / 60.000	1 / 100.000	1 / 120.000	1 / 150.000	1 / 300.000

<b>FM-18 RMW</b>					
M	H	S1	S2	S5	U3

1.600,00	1.715,00	1.825,00	2.060,00	2.120,00	-
----------	----------	----------	----------	----------	---

1.530,00	1.645,00	1.755,00	1.990,00	2.050,00	2.090,00
1.600,00	1.715,00	1.825,00	2.060,00	2.120,00	2.160,00
1.860,00	1.975,00	2.085,00	2.320,00	2.380,00	2.420,00

1.625,00	1.805,00	1.795,00	2.115,00	2.195,00	-
1.880,00	2.060,00	2.050,00	2.370,00	2.450,00	-
2.415,00	2.595,00	2.585,00	2.905,00	2.985,00	-

1.565,00	1.745,00	1.735,00	2.055,00	2.135,00	-
1.805,00	1.985,00	1.975,00	2.295,00	2.375,00	-

1.750,00	1.930,00	1.920,00	2.240,00	2.320,00	-
2.345,00	2.525,00	2.515,00	2.835,00	2.915,00	-
3.055,00	3.235,00	3.225,00	3.545,00	3.625,00	-
2.120,00	2.300,00	2.290,00	2.610,00	2.690,00	-

1.620,00	1.800,00	1.790,00	2.110,00	2.190,00	-
1.885,00	2.065,00	2.055,00	2.375,00	2.455,00	-
2.030,00	2.210,00	2.200,00	2.520,00	2.600,00	-

2.420,00	-	-	-	-	-
2.570,00	-	-	-	-	-

2.040,00	-	-	-	-	-
2.590,00	-	-	-	-	-
3.550,00	-	-	-	-	-

2.450,00	-	-	-	-	-
2.550,00	-	-	-	-	-

2.130,00	-	-	-	-	-
2.325,00	-	-	-	-	-
3.490,00	-	-	-	-	-

2.350,00	-	-	-	-	-
2.450,00	-	-	-	-	-
3.745,00	-	-	-	-	-

2.440,00	-	-	-	-	-
2.515,00	-	-	-	-	-
4.405,00	-	-	-	-	-

NOT : 19i indikatör modeli için yukarıdaki fiyatlara + 150 TL eklenerek fiyat belirlenir.



**FM-18****FM-28**

ÇİFT RS-232 ÇIKIŞ

**RMW**

35 x 26 SX



LURS platform



D platform (Sac Siperlik)

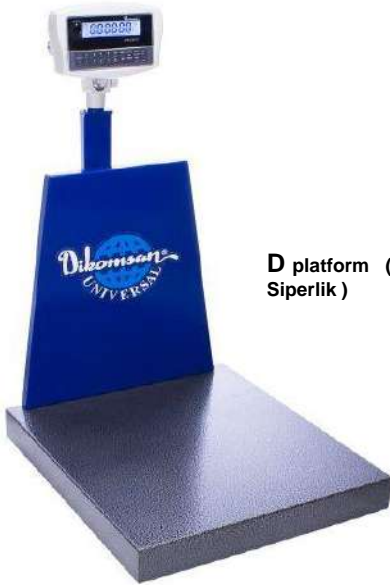

Opsiyonlar :



RS-232 Bağlantısı için 110 TL + KDV fiyata ilave edilir; modeller FM-18, RMW



Bluetooth Bağlantısı için 210 TL + KDV fiyata ilave edilir; modeller RMW

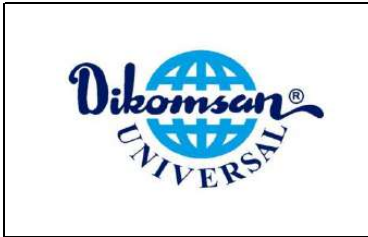

PASLANMAZ TARTIM BASKÜLLERİ

Boyut	Tip	Cins	Kapasiteler	ENDÜSTRİYEL KULLANIM							TİCARİ KULLANIM <b>M</b>		
				ENDÜSTRİYEL KULLANIM							TİCARİ KULLANIM <b>M</b>		
				DBS	RHW			APS			RHW	APS	
L	L	M	H	S	L	M	A	A					
30 x 40 cm	LAR	S	30 kg....150 kg	1/15.000	1/15.000	1/30.000	1/60.000	1/100.000	1/15.000	1/30.000	1/3.000 Çift Taksimat	1/3.000	
				1.275,00	1.585,00	1.610,00	1.725,00	1.835,00	2.475,00	2.500,00	1.660,00	2.460,00	
32 x 24 cm	K	S	30 kg.....60 kg	1.565,00	1.875,00	1.900,00	2.015,00	2.125,00	2.765,00	2.790,00	1.950,00	2.750,00	
35 x 26 cm	D	S	30 kg...60 kg	1.275,00	1.585,00	1.610,00	1.725,00	1.835,00	2.475,00	2.500,00	1.660,00	2.460,00	
				1.535,00	1.845,00	1.870,00	1.985,00	2.095,00	2.735,00	2.760,00	1.920,00	2.720,00	
35 x 30 cm	D	SX	30 kg....60 kg	1.490,00	1.800,00	1.825,00	1.940,00	2.050,00	2.690,00	2.715,00	1.875,00	2.675,00	
				1.675,00	1.985,00	2.010,00	2.125,00	2.235,00	2.875,00	2.900,00	2.060,00	2.860,00	
35 x 45 cm	U	SPS	30 kg....300 kg	1.435,00	1.745,00	1.815,00	1.995,00	1.985,00	2.635,00	2.705,00	1.820,00	2.620,00	
35 x 40 cm	D	SPS	30 kg....150 kg	SX	1.510,00	1.820,00	1.890,00	2.070,00	2.060,00	2.710,00	2.780,00	1.895,00	2.695,00
				SX	2.045,00	2.355,00	2.425,00	2.605,00	2.595,00	3.245,00	3.315,00	2.430,00	3.230,00
				SS	-	-	-	-	-	-	-	3.775,00	4.575,00
		A		RS	1.590,00	1.900,00	1.970,00	2.150,00	2.140,00	2.790,00	2.860,00	1.975,00	2.775,00
				RSX	2.485,00	2.795,00	2.865,00	3.045,00	3.035,00	3.685,00	3.755,00	2.870,00	3.670,00
40 x 50 cm	U	SPS	30 kg....300 kg	SX	1.750,00	2.060,00	2.130,00	2.310,00	2.300,00	2.950,00	3.020,00	2.135,00	2.935,00
				SX	1.975,00	2.285,00	2.355,00	2.535,00	2.525,00	3.175,00	3.245,00	2.360,00	3.160,00
				SX	2.685,00	2.995,00	3.065,00	3.245,00	3.235,00	3.885,00	3.955,00	3.070,00	3.870,00
42 x 33 cm	D	S	30 kg .....150 kg	SX	1.515,00	1.825,00	1.895,00	2.075,00	2.065,00	2.715,00	2.785,00	1.900,00	2.700,00
				SX	1.660,00	1.970,00	2.040,00	2.220,00	2.210,00	2.860,00	2.930,00	2.045,00	2.845,00
				SS	-	-	-	-	-	-	-	2.445,00	3.245,00
42 x 52 cm	U	SPS	30 kg ....150 kg	1.985,00	2.295,00	2.365,00	-	-	3.185,00	3.255,00	2.370,00	3.170,00	
45 x 35 cm	U	SPS	30 kg....300 kg	1.435,00	1.745,00	1.815,00	1.995,00	1.985,00	2.635,00	2.705,00	1.820,00	2.620,00	
45 x 60 cm	U	SPS	30 kg....300 kg	1.965,00	2.275,00	2.560,00	-	-	3.165,00	3.450,00	2.350,00	3.150,00	
50 x 60 cm	E	SX	60 kg....300 kg	SX	2.575,00	2.885,00	-	-	-	3.775,00	-	2.960,00	3.760,00
				SX	2.005,00	2.315,00	2.600,00	-	-	3.205,00	-	2.390,00	3.190,00
				SX	2.965,00	3.275,00	3.560,00	-	-	4.165,00	-	3.350,00	4.150,00
				SS	-	-	-	-	-	-	-	4.730,00	5.530,00
60 x 45 cm	U	SPS	30 kg....300 kg	1.965,00	2.275,00	2.560,00	-	-	3.165,00	3.450,00	2.350,00	3.150,00	
60 x 70 cm	D	SPS	30 kg....600 kg	SX	2.905,00	3.215,00	3.500,00	-	-	4.105,00	-	3.290,00	4.090,00
				SX	3.945,00	4.255,00	4.540,00	-	-	5.145,00	-	4.330,00	5.130,00
				SS	-	-	-	-	-	-	-	5.855,00	6.655,00
70 x 80 cm	D	SPS	30 kg....600 kg	SX	3.160,00	3.470,00	3.755,00	-	-	4.360,00	-	3.545,00	4.345,00
				SX	4.575,00	4.885,00	5.170,00	-	-	5.775,00	-	4.960,00	5.760,00
				SS	-	-	-	-	-	-	-	6.710,00	7.510,00
80 x 90 cm	D	SPS	30 kg....600 kg	SX	3.820,00	4.130,00	4.415,00	-	-	5.020,00	-	4.205,00	5.005,00
				SX	5.585,00	5.895,00	6.180,00	-	-	6.785,00	-	5.970,00	6.770,00
				SS	-	-	-	-	-	-	-	8.120,00	8.920,00

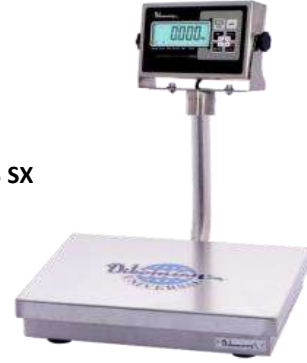
**DBS****RHW****RSW****APS****35x26 SX****42x33 SX****42 x 52 U****D platform  
(Sac Siperlik )****Opsiyonlar :**

RS-232 Bağlantısı için 110 TL + KDV fiyata ilave edilir; modeller RHW, RSW, APS



Bluetooth Bağlantısı için 210 TL + KDV fiyata ilave edilir; modeller RHW ve RSW

**Not :**

Paslanmaz load cell tüm platformlarımıza takılabilmektedir. Maximum 1/3.000 çözünürlükte çalışmaktadır.



Boyut	Tip	Cins	Kapasiteler
-------	-----	------	-------------

35 x 26 cm	D	B	30 kg.....60 kg
		S	
		SX	

35 x 40 cm	E	B	30 kg.....150 kg
	W	B	

35 x 45 cm 45 x 35 cm	U	SBS	30 kg.....150 kg
		SPS	

40 x 50 cm	E	B	60 kg.....300 kg	
		D		B
				SPS
	SX			
	U	SBS		
		SPS		

42 x 33 cm	D	B	30 kg.....150 kg
		S	
		SX	

42 x 52 cm	U	SBS	60 kg.....300 kg
		SPS	

45 x 60 cm 60 x 45 cm	U	SBS	60kg.....300 kg
		SPS	

50 x 60 cm	E	B	60kg.....300 kg
		SX	
	D	B	

60 x 70 cm	E	B	60 kg.....300 kg
		D	
	SPS		

70 x 80 cm	E	B	60kg.....600 kg
		D	
	SPS		

80 x 90 cm	E	B	60kg.....600 kg
		D	
	SPS		

## FİYAT HESAPLAMALI BASKÜLLER

60 kg x 10 / 20 g 150 kg x 20 / 50 g 300 kg x 50 / 100g	60 kg x 10 / 20 g 150 kg x 20 / 50 g 300 kg x 50 / 100g	60 kg x 10 / 20 g 150 kg x 20 / 50 g 300 kg x 50 / 100g
---	---	---

RCP	SEP-IN-R	RSP
-----	----------	-----

A		
---	--	--

1.330,00	1.560,00	1.960,00
1.400,00	1.630,00	2.030,00
1.660,00	1.890,00	2.290,00

1.210,00	1.440,00	1.840,00
1.630,00	1.860,00	2.260,00

1.320,00	1.550,00	1.950,00
1.560,00	1.790,00	2.190,00

1.285,00	1.515,00	1.915,00
1.505,00	1.735,00	2.135,00
2.100,00	2.330,00	2.730,00
2.810,00	3.040,00	3.440,00
1.775,00	2.005,00	2.405,00
1.875,00	2.105,00	2.505,00

1.375,00	1.605,00	2.005,00
1.640,00	1.870,00	2.270,00
1.785,00	2.015,00	2.415,00

1.960,00	2.190,00	2.590,00
2.110,00	2.340,00	2.740,00

1.990,00	2.220,00	2.620,00
2.090,00	2.320,00	2.720,00

1.455,00	1.685,00	2.085,00
2.700,00	2.930,00	3.330,00
1.580,00	1.810,00	2.210,00

1.670,00	1.900,00	2.300,00
1.865,00	2.095,00	2.495,00
3.030,00	3.260,00	3.660,00

1.890,00	2.120,00	2.520,00
1.990,00	2.220,00	2.620,00
3.285,00	3.515,00	3.915,00

1.980,00	2.210,00	2.610,00
2.055,00	2.285,00	2.685,00
3.945,00	4.175,00	4.575,00

**RCP**



**SEP-IN**



**RSP**



42 x 33 SX



35 x 40 B



**D platform**  
(Sac Siperlik)



				SAYICI BASKÜLLER																			
				60kg x 5g x 0,8g 150kg x10g x 2g 300kg x20g x 4g		60kg x 2g x 0,8g 150kg x 5g x 1,5g 300kg x 10g x 3g		60kg x 5g x 0,8g 150kg x10g x 2g 300kg x20g x 4g		60kg x 2g x 0,5g 150kg x 5g x 1,2g 300kg x 10g x 2,5g 600kg x 20g x 5g		60kg x 1g x 0,4g 150kg x 2g x 1g 300kg x 5g x 2g 600kg x 10g x 4g		50kg x 0,5g x 0,25g 100kg x 1g x 0,5g 200kg x 2g x 1g		75kg x 0,5g x 0,5g 150kg x 1g x 0,5g							
				1/15.000		1/30.000		1/15.000		1/30.000		1/60.000		1/100.000		1/150.000							
				1/75.000		1/100.000		1/75.000		1/120.000		1/150.000		1/150.000		1/150.000							
				DCC				RCC															
BOYUT				TİP		Cins		Kapasiteler		L		M		H		S1		S5					
30 x 40 cm				LAR		S		30 kg.....60 kg		1165,00		1190,00		1405,00		1430,00		1545,00		1655,00		1890,00	
35 x 26 cm				D		B		30 kg.....60 kg		1095,00		1120,00		1335,00		1360,00		1475,00		1585,00		1820,00	
						S				1165,00		1190,00		1405,00		1430,00		1545,00		1655,00		1890,00	
						SX				1425,00		1450,00		1665,00		1690,00		1805,00		1915,00		2150,00	
42 x 33 cm				D		B		30 kg.....150 kg		1140,00		1210,00		1380,00		1450,00		1630,00		1630,00		1940,00	
						S				1405,00		1475,00		1645,00		1715,00		1895,00		1895,00		2205,00	
						SX				1550,00		1620,00		1790,00		1860,00		2040,00		2040,00		2350,00	
35 x 45 cm 45 x 35 cm				U		SBS		30 kg.....150 kg		1085,00		1155,00		1325,00		1395,00		1575,00		1575,00		1885,00	
						SPS				1325,00		1395,00		1565,00		1635,00		1815,00		1815,00		2125,00	
35 x 40 cm				D		B		30 kg.....200 kg		1145,00		1215,00		1385,00		1455,00		1635,00		1635,00		1945,00	
						SPS				1400,00		1470,00		1640,00		1710,00		1890,00		1890,00		2200,00	
40 x 50 cm				U		SPS		30 kg.....300 kg		1640,00		1710,00		1880,00		1950,00		2130,00		2130,00		2440,00	
				D		B				1270,00		1340,00		1510,00		1580,00		1760,00		1760,00		2070,00	
						SPS				1865,00		1935,00		2105,00		2175,00		2355,00		2355,00		2665,00	
50 x 60 cm				U		B		60kg.....300 kg		1315,00		1600,00		1555,00		1840,00		-		-		-	
				D		B				1345,00		1630,00		1585,00		1870,00		-		-		-	
						SPS				1895,00		2180,00		2135,00		2420,00		-		-		-	
60 x 70 cm				U		B		60kg.....600 kg		1550,00		1835,00		1790,00		2075,00		-		-		-	
				D		B				1630,00		1915,00		1870,00		2155,00		-		-		-	
						SPS				2795,00		3080,00		3035,00		3320,00		-		-		-	
70 x 80 cm				E		B		60kg.....600 kg		1655,00		1940,00		1895,00		2180,00		-		-		-	
				D		B				1755,00		2040,00		1995,00		2280,00		-		-		-	
						SPS				3050,00		3335,00		3290,00		3575,00		-		-		-	
80 x 90 cm				E		B		60kg.....600 kg		1745,00		2030,00		1985,00		2270,00		-		-		-	
				D		B				1820,00		2105,00		2060,00		2345,00		-		-		-	
						SPS				3710,00		3995,00		3950,00		4235,00		-		-		-	

**DCC**



**RCC**



Opsiyonlar :



RS-232 Bağlantısı için 110 TL + KDV fiyata ilave edilir; modeller RCC



Bluetooth Bağlantısı için 210 TL + KDV fiyata ilave edilir; modeller RCC

				SAYICI BASKÜLLER				
				30 kg x 2 g x 0,5 g 60 kg x 5 g x 1 g 150 kg x 10 g x 2 g 300 kg x 20 g x 5 g 600 kg x 50 g x 10 g	30kg x 1 g x 0,5g 60kg x 2g x 1g 150kg x 5g x 2g 300kg x 10g x 4g 600kg x 20g x 10g	30kg x 0,5g x 0,25g 60kg x 1g x 0,5g 150kg x 2g x 1g 300kg x 5g x 2g	50kg x 0,5g x 0,4g 100kg x 1g x 0,5g 200kg x 2g x 1g	60kg x 10/20g x 0,5g 150kg x 20/50g x 1,2g 300kg x 50/100g x 2,5g 600kg x 100/200g x 5g
				DC				
Boyut	Tip	Cins	Kapasiteler	L	M	H	S1	SEC-IN
30 x 40 cm	LAR	S	30 kg.....60 kg	1.665,00	1.690,00	1.805,00	1.915,00	1.545,00
35 x 26 cm	D	B	30 kg.....60 kg	1.595,00	1.620,00	1.735,00	1.845,00	1.475,00
		S		1.665,00	1.690,00	1.805,00	1.915,00	1.545,00
		SX		1.925,00	1.950,00	2.065,00	2.175,00	1.805,00
42 x 33 cm	D	B	30 kg.....150 kg	1.640,00	1.710,00	1.890,00	1.880,00	1.520,00
		S		1.905,00	1.975,00	2.155,00	2.145,00	1.785,00
		SX		2.050,00	2.120,00	2.300,00	2.290,00	1.930,00
35 x 45 cm 45 x 35 cm	UR	SBS	30 kg.....150 kg	1.585,00	1.655,00	1.835,00	1.825,00	1.465,00
		SPS		1.825,00	1.895,00	2.075,00	2.065,00	1.705,00
35 x 40 cm	D	B	30 kg.....150 kg	1.645,00	1.715,00	1.895,00	1.885,00	1.525,00
		SPS		1.900,00	1.970,00	2.150,00	2.140,00	1.780,00
40 x 50 cm	D	SPS	60kg.....300 kg	2.140,00	2.210,00	2.390,00	2.380,00	2.020,00
		B		1.770,00	1.840,00	2.020,00	2.010,00	1.650,00
		SPS		2.365,00	2.435,00	2.615,00	2.605,00	2.245,00
50 x 60 cm	D	B	60kg.....300 kg	1.815,00	2.100,00	-	-	1.695,00
		B		1.845,00	2.130,00	-	-	1.725,00
		SPS		2.395,00	2.680,00	-	-	2.275,00
60 x 70 cm	D	B	60kg.....600 kg	2.050,00	2.335,00	-	-	1.930,00
		B		2.130,00	2.415,00	-	-	2.010,00
		SPS		3.295,00	3.580,00	-	-	3.175,00
70 x 80 cm	D	B	60kg.....600 kg	2.155,00	2.440,00	-	-	2.035,00
		B		2.255,00	2.540,00	-	-	2.135,00
		SPS		3.550,00	3.835,00	-	-	3.430,00
80 x 90 cm	D	B	60kg.....600 kg	2.245,00	2.530,00	-	-	2.125,00
		B		2.320,00	2.605,00	-	-	2.200,00
		SPS		4.210,00	4.495,00	-	-	4.090,00



**DC**



**SEC-IN**



LURS 42x52



**D platform  
(Sac Siperlik )**

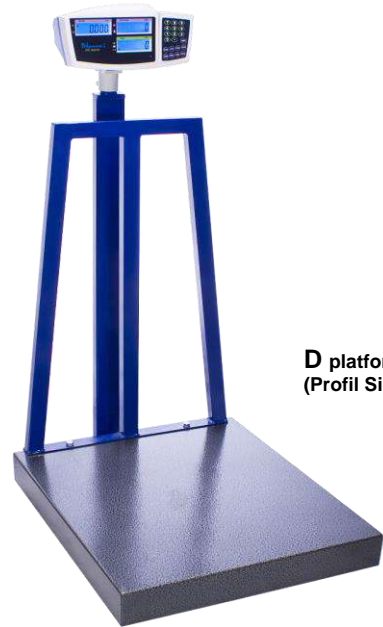

**D platform  
(Profil Siperlik )**

Opsiyonlar :  RS-232 Bağlantısı için 110 TL + KDV fiyata ilave edilir.



## KAĞIT FİŞ YAZICILI TARTIM BASKÜLLERİ

60 kg x 5 g  
150 kg x 10 g  
300 kg x 20 g  
600 kg x 50 g

A3

W22

FB530

FB530-R

L

Boyut	Tip	Cins	Kapasiteler
-------	-----	------	-------------

30 x 40 cm	LAR	S	25 kg.....60 kg
------------	-----	---	-----------------

35 x 26 cm	D	B	25 kg.....60 kg
		S	
		SX	

35 x 40 cm	D	B	30 kg.....150 kg
		SPS	
		SX	

35 x 45 cm 45 x 35 cm	U	SBS	30 kg.....150 kg
		SPS	

40 x 50 cm	D	B	30 kg.....300 kg
		SPS	
		SX	
	U	SPS	

42 x 33 cm	D	B	30 kg.....150 kg
		S	
		SX	

42 x 52 cm	U	SBS	60 kg.....300 kg
		SPS	

45 x 60 cm 60 x 45 cm	U	SBS	60 kg.....300 kg
		SPS	

46 x 60 cm	LAR	SBS	60 kg.....150 kg
		SPS	

50 x 60 cm	D	B	60kg.....300 kg
		SPS	
		SX	

60 x 70 cm	E	B	60 kg.....300 kg
	D	B	
		SPS	

70 x 80 cm	E	B	60kg.....600 kg
	D	B	
		SPS	

80 x 90 cm	E	B	60kg.....600 kg
	D	B	
		SPS	

2.030,00	2.360,00	1.875,00	2.025,00
----------	----------	----------	----------

1.960,00	2.290,00	1.805,00	1.955,00
2.030,00	2.360,00	1.875,00	2.025,00
2.290,00	2.620,00	2.135,00	2.285,00

2.010,00	2.340,00	1.855,00	2.005,00
2.265,00	2.595,00	2.110,00	2.260,00
2.800,00	3.130,00	2.645,00	2.795,00

1.950,00	2.280,00	1.795,00	1.945,00
2.190,00	2.520,00	2.035,00	2.185,00

2.135,00	2.465,00	1.980,00	2.130,00
2.730,00	3.060,00	2.575,00	2.725,00
3.440,00	3.770,00	3.285,00	3.435,00
2.505,00	2.835,00	2.350,00	2.500,00

2.005,00	2.335,00	1.850,00	2.000,00
2.270,00	2.600,00	2.115,00	2.265,00
2.415,00	2.745,00	2.260,00	2.410,00

2.590,00	2.920,00	2.435,00	2.585,00
2.740,00	3.070,00	2.585,00	2.735,00

2.620,00	2.950,00	2.465,00	2.615,00
2.720,00	3.050,00	2.565,00	2.715,00

2.625,00	2.955,00	2.470,00	2.620,00
2.725,00	3.055,00	2.570,00	2.720,00

2.210,00	2.540,00	2.055,00	2.205,00
2.760,00	3.090,00	2.605,00	2.755,00
3.720,00	4.050,00	3.565,00	3.715,00

2.300,00	2.630,00	2.145,00	2.295,00
2.495,00	2.825,00	2.340,00	2.490,00
3.660,00	3.990,00	3.505,00	3.655,00

2.520,00	2.850,00	2.365,00	2.515,00
2.620,00	2.950,00	2.465,00	2.615,00
3.915,00	4.245,00	3.760,00	3.910,00

2.610,00	2.940,00	2.455,00	2.605,00
2.685,00	3.015,00	2.530,00	2.680,00
4.575,00	4.905,00	4.420,00	4.570,00

**A3**



**FB530**



**FB530R**



Weight Bill	
NO	0000
Date	2013-09-12
Time	13:24:29
CarNo	00010
Cargo	020
Gross	0.00 (kg)
Tare	3.96 (kg)
Net	0.00 (kg)

DATE	: 2011/06/24
TIME	: 14:17:39
TICKET NO.	0001
G	3.84kg
T	0.00kg
PT	0.00kg
N	3.84kg
DATE: 2011/06/24	
TIME: 14:18:16	
TICKET NO. 0002	
G	4.85kg
T	0.00kg
PT	0.00kg
N	4.85kg
DATE: 2011/06/24	
TIME: 14:18:41	
TICKET NO. 0003	
G	5.22kg
T	0.48kg
PT	0.00kg
N	4.82kg

DATE: 2011/06/24	
TIME: 14:20:07	
TICKET NO. 0001	
G	12Pos
T	1Pos
PT	0Pos
N	11Pos
DATE: 2011/06/24	
TIME: 14:23:21	
TOTAL NUMBER	
OF TICKETS 0001	
TOTAL	
NET	
11Pos	

**E platform**



**LURS 42x52**



# FIYAT LİSTESİ

05.04.2021  
www.dikomsan.com

				YAZICILI TARTIM BASKÜLLERİ								
				FİŞ YAZICILI						ETİKET YAZICILI		
				60 kg x 5 g 150 kg x 10 g 300 kg x 20 g 600 kg x 50 g	60 kg x 2 g 150 kg x 5 g 300 kg x 10 g 600 kg x 20 g	60 kg x 1 g 150 kg x 2 g 300 kg x 5 g	60 kg x 5 g 150 kg x 10 g 300 kg x 20 g 600 kg x 50 g	60 kg x 2 g 150 kg x 5 g 300 kg x 10 g 600 kg x 20 g	60 kg x 1 g 150 kg x 2 g 300 kg x 5 g			
				HWP-CT						HWP-CL		
BOYUT	TİP	Cins	Kapasiteler	L	M	H	L	M	H			
30 x 40 cm	LAR	S	15 kg.....60 kg	2.165,00	2.205,00	2.320,00	2.545,00	2.585,00	2.700,00			
35 x 26 cm	D	B	15 kg.....60 kg	2.095,00	2.135,00	2.250,00	2.475,00	2.515,00	2.630,00			
		S		2.165,00	2.205,00	2.320,00	2.545,00	2.585,00	2.700,00			
		SX		2.425,00	2.465,00	2.580,00	2.805,00	2.845,00	2.960,00			
35 x 40 cm	D	B	30 kg.....150 kg	2.160,00	2.230,00	2.410,00	2.540,00	2.610,00	2.790,00			
		SPS		2.415,00	2.485,00	2.665,00	2.795,00	2.865,00	3.045,00			
		SX		2.950,00	3.020,00	3.200,00	3.330,00	3.400,00	3.580,00			
35 x 45 cm 45 x 35 cm	U	SBS	30 kg.....150 kg	2.100,00	2.170,00	2.350,00	2.480,00	2.550,00	2.730,00			
		SPS		2.340,00	2.410,00	2.590,00	2.720,00	2.790,00	2.970,00			
40 x 50 cm	D	B	30 kg.....300 kg	2.285,00	2.355,00	2.535,00	2.665,00	2.735,00	2.915,00			
		SPS		2.880,00	2.950,00	3.130,00	3.260,00	3.330,00	3.510,00			
		SX		3.590,00	3.660,00	3.840,00	3.970,00	4.040,00	4.220,00			
	U	SPS	2.655,00	2.725,00	2.905,00	3.035,00	3.105,00	3.285,00				
42 x 33 cm	D	B	30 kg.....150 kg	2.155,00	2.225,00	2.405,00	2.535,00	2.605,00	2.785,00			
		S		2.420,00	2.490,00	2.670,00	2.800,00	2.870,00	3.050,00			
		SX		2.565,00	2.635,00	2.815,00	2.945,00	3.015,00	3.195,00			
42 x 52 cm	U	SBS	60 kg.....300 kg	2.740,00	3.025,00	-	3.120,00	3.405,00	-			
		SPS		2.890,00	3.175,00	-	3.270,00	3.555,00	-			
45 x 60 cm 60 x 45 cm	U	SBS	60 kg.....300 kg	2.770,00	3.055,00	-	3.150,00	3.435,00	-			
		SPS		2.870,00	3.155,00	-	3.250,00	3.535,00	-			
46 x 60 cm	LAR	SBS	60 kg.....150 kg	2.775,00	3.060,00	-	3.155,00	3.440,00	-			
		SPS		2.875,00	3.160,00	-	3.255,00	3.540,00	-			
50 x 60 cm	D	B	60kg.....300 kg	2.360,00	2.645,00	-	2.740,00	3.025,00	-			
		SPS		2.910,00	3.195,00	-	3.290,00	3.575,00	-			
		SX		3.870,00	4.155,00	-	4.250,00	4.535,00	-			
60 x 70 cm	E	B	60 kg.....300 kg	2.450,00	2.735,00	-	2.830,00	3.115,00	-			
	D	B		2.645,00	2.930,00	-	3.025,00	3.310,00	-			
		SPS		3.810,00	4.095,00	-	4.190,00	4.475,00	-			
70 x 80 cm	E	B	60kg.....600 kg	2.670,00	2.955,00	-	3.050,00	3.335,00	-			
	D	B		2.770,00	3.055,00	-	3.150,00	3.435,00	-			
		SPS		4.065,00	4.350,00	-	4.445,00	4.730,00	-			
80 x 90 cm	E	B	60kg.....600 kg	2.760,00	3.045,00	-	3.140,00	3.425,00	-			
	D	B		2.835,00	3.120,00	-	3.215,00	3.500,00	-			
		SPS		4.725,00	5.010,00	-	5.105,00	5.390,00	-			

### HWP-CT

#### Termal Fiş



### HWP-CL

#### Termal Etiket



D platform  
(Sac Siperlik)

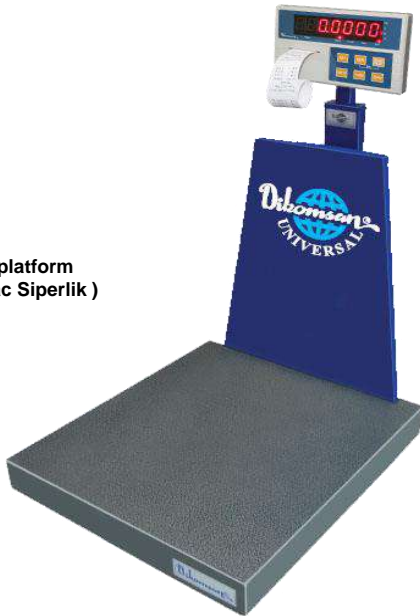

D platform  
(Profil Siperlik)



				YAZICILI SAYICI BASKÜLLER					
				FİŞ YAZICILI			ETİKET YAZICILI		
60 kg x 5 g	60 kg x 2 g	60 kg x 1 g	60 kg x 5 g	60 kg x 2 g	60 kg x 1 g				
150 kg x 10 g	150 kg x 5 g	150 kg x 2 g	150 kg x 10 g	150 kg x 5 g	150 kg x 2 g				
300 kg x 20 g	300 kg x 10 g	300 kg x 5 g	300 kg x 20 g	300 kg x 10 g	300 kg x 5 g				
600 kg x 50 g	600 kg x 20 g		600 kg x 50 g	600 kg x 20 g					
HCP-CT (LCD Gösterge)			HCP-CL (LCD Gösterge)						
L	M	H	L	M	H				
BOYUT	TİP	Cins	Kapasiteler						
30 x 40 cm	LAR	S	30 kg.....60 kg	2.545,00	2.585,00	2.700,00	2.810,00	2.850,00	2.965,00
35 x 26 cm	D	B	30 kg.....60 kg	2.475,00	2.515,00	2.630,00	2.740,00	2.780,00	2.895,00
		S		2.545,00	2.585,00	2.700,00	2.810,00	2.850,00	2.965,00
		SX		2.805,00	2.845,00	2.960,00	3.070,00	3.110,00	3.225,00
35 x 40 cm	D	B	30 kg.....150 kg	2.540,00	2.610,00	2.790,00	2.805,00	2.875,00	3.055,00
		SPS		2.795,00	2.865,00	3.045,00	3.060,00	3.130,00	3.310,00
		SX		3.330,00	3.400,00	3.580,00	3.595,00	3.665,00	3.845,00
35 x 45 cm	U	SBS	30 kg.....150 kg	2.480,00	2.550,00	2.730,00	2.745,00	2.815,00	2.995,00
		SPS		2.720,00	2.790,00	2.970,00	2.985,00	3.055,00	3.235,00
40 x 50 cm	D	B	30 kg.....300 kg	2.665,00	2.735,00	2.915,00	2.930,00	3.000,00	3.180,00
		SPS		3.260,00	3.330,00	3.510,00	3.525,00	3.595,00	3.775,00
		SX		3.970,00	4.040,00	4.220,00	4.235,00	4.305,00	4.485,00
	U	SPS	3.035,00	3.105,00	3.285,00	3.300,00	3.370,00	3.550,00	
42 x 33 cm	D	B	30 kg.....150 kg	2.535,00	2.605,00	2.785,00	2.800,00	2.870,00	3.050,00
		S		2.800,00	2.870,00	3.050,00	3.065,00	3.135,00	3.315,00
		SX		2.945,00	3.015,00	3.195,00	3.210,00	3.280,00	3.460,00
42 x 52 cm	U	SBS	60 kg.....300 kg	3.120,00	3.405,00	-	3.385,00	3.670,00	-
		SPS		3.270,00	3.555,00	-	3.535,00	3.820,00	-
45 x 60 cm 60 x 45 cm	U	SBS	60 kg.....300 kg	3.150,00	3.435,00	-	3.415,00	3.700,00	-
		SPS		3.250,00	3.535,00	-	3.515,00	3.800,00	-
46 x 60 cm	LAR	SBS	60 kg.....150 kg	3.155,00	3.440,00	-	3.420,00	3.705,00	-
		SPS		3.255,00	3.540,00	-	3.520,00	3.805,00	-
50 x 60 cm	D	B	60kg.....300 kg	2.740,00	3.025,00	-	3.005,00	3.290,00	-
		SPS		3.290,00	3.575,00	-	3.555,00	3.840,00	-
		SX		4.250,00	4.535,00	-	4.515,00	4.800,00	-
60 x 70 cm	E	B	60 kg.....300 kg	2.830,00	3.115,00	-	3.095,00	3.380,00	-
	D	B		3.025,00	3.310,00	-	3.290,00	3.575,00	-
		SPS		4.190,00	4.475,00	-	4.455,00	4.740,00	-
70 x 80 cm	D	B	60kg.....600 kg	3.050,00	3.335,00	-	3.315,00	3.600,00	-
		B		3.150,00	3.435,00	-	3.415,00	3.700,00	-
		SPS		4.445,00	4.730,00	-	4.710,00	4.995,00	-
80 x 90 cm	D	B	60kg.....600 kg	3.140,00	3.425,00	-	3.405,00	3.690,00	-
		B		3.215,00	3.500,00	-	3.480,00	3.765,00	-
		SPS		5.105,00	5.390,00	-	5.370,00	5.655,00	-

### HCP-CT

Fiş veren Yazıcı



### HCP-CL

Etiket veren Yazıcı



opsiyonel harici etiket yazıcı :



# FIYAT LİSTESİ

05.04.2021

www.dikomsan.com



Tartım çbz.  
Sayım çbz.

## YAZICILI TARTIM ve YAZICILI SAYICI BASKÜLLER

60 kg x 5 g 150 kg x 10 g 300 kg x 20 g 600 kg x 50 g				60 kg x 2 g 150 kg x 5 g 300 kg x 10 g 600 kg x 20 g				60 kg x 1 g 150 kg x 2 g 300 kg x 5 g				50 kg x 0.5 g 100 kg x 1 g 200 kg x 2 g				60 kg x 2 g 150 kg x 5 g 300 kg x 10 g 600 kg x 20 g			60 kg x 1 g 150 kg x 2 g 300 kg x 5 g			50 kg x 0.5 g 100 kg x 1 g 200 kg x 2 g							
1 / 15.000				1 / 30.000				1 / 60.000				1 / 100.000				1 / 30.000			1 / 60.000			1 / 100.000							
1 / 60.000				1/100.000				1/120.000				1/150.000				1/100.000			1/120.000			1/150.000							
SPW												SPC																	
L				M				H				S1				M		H		S1									
30 x 40 cm				LAR				S				6 kg.....60 kg				5.915,00		5.955,00		6.070,00		6.180,00		6.065,00		6.180,00		6.290,00	
35 x 26 cm				D				B				6 kg.....60 kg				5.845,00		5.885,00		6.000,00		6.110,00		5.995,00		6.110,00		6.220,00	
								S								6.065,00		6.180,00		6.290,00									
								SX								6.325,00		6.440,00		6.550,00									
35 x 40 cm				D				B				15 kg.....150 kg				5.895,00		5.980,00		6.160,00		6.150,00		6.090,00		6.270,00		6.260,00	
								SPS								6.150,00		6.235,00		6.415,00		6.405,00		6.345,00		6.525,00		6.515,00	
								SX								6.685,00		6.770,00		6.950,00		6.940,00		6.880,00		7.060,00		7.050,00	
35 x 45 cm				U				SBS				30 kg.....150 kg				5.835,00		5.920,00		6.100,00		6.090,00		6.030,00		6.210,00		6.200,00	
								SPS								6.075,00		6.160,00		6.340,00		6.330,00		6.270,00		6.450,00		6.440,00	
40 x 50 cm				D				B				30 kg.....300 kg				6.020,00		6.105,00		6.285,00		6.275,00		6.215,00		6.395,00		6.385,00	
								SPS								6.615,00		6.700,00		6.880,00		6.870,00		6.810,00		6.990,00		6.980,00	
								SX								7.325,00		7.410,00		7.590,00		7.580,00		7.520,00		7.700,00		7.690,00	
				U				SPS				6.390,00		6.475,00		6.655,00		6.645,00		6.585,00		6.765,00		6.755,00					
42 x 33 cm				D				B				30 kg.....150 kg				5.890,00		5.975,00		6.155,00		6.145,00		6.085,00		6.265,00		6.255,00	
								S								6.155,00		6.240,00		6.420,00		6.410,00		6.350,00		6.530,00		6.520,00	
								SX								6.300,00		6.385,00		6.565,00		6.555,00		6.495,00		6.675,00		6.665,00	
42 x 52 cm				U				SBS				60 kg.....300 kg				6.475,00		6.775,00		-		-		6.885,00		-		-	
								SPS								6.625,00		6.925,00		-		-		7.035,00		-		-	
45 x 60 cm 60 x 45 cm				U				SBS				60 kg.....300 kg				6.505,00		6.805,00		-		-		6.915,00		-		-	
								SPS								6.605,00		6.905,00		-		-		7.015,00		-		-	
46 x 60 cm				LAR				SBS				60 kg.....150 kg				6.510,00		6.810,00		-		-		6.920,00		-		-	
								SPS								6.610,00		6.910,00		-		-		7.020,00		-		-	
50 x 60 cm				D				B				60kg.....300 kg				6.095,00		6.395,00		-		-		6.505,00		-		-	
								SPS								6.645,00		6.945,00		-		-		7.055,00		-		-	
								SX								7.605,00		7.905,00		-		-		8.015,00		-		-	
60 x 70 cm				E				B				60 kg.....300 kg				6.185,00		6.485,00		-		-		6.595,00		-		-	
								D								6.380,00		6.680,00		-		-		6.790,00		-		-	
								SPS								7.545,00		7.845,00		-		-		7.955,00		-		-	
70 x 80 cm				E				B				60kg.....600 kg				6.405,00		6.705,00		-		-		6.815,00		-		-	
								D								6.505,00		6.805,00		-		-		6.915,00		-		-	
								SPS								7.800,00		8.100,00		-		-		8.210,00		-		-	
80 x 90 cm				E				B				60kg.....600 kg				6.495,00		6.795,00		-		-		6.905,00		-		-	
								D								6.570,00		6.870,00		-		-		6.980,00		-		-	
								SPS								8.460,00		8.760,00		-		-		8.870,00		-		-	



### SPW

#### Yazıcılı - Tartım Baskülü



### SPC

#### Yazıcılı - Sayıcı Baskül



opsiyonel harici etiket yazıcı :

3 inç veya 4 inç



					Çift Şase - Tek Yük Hücreli Büyük Basküller 1D									
					600 kg x 100g 1500 kg x 200g		600 kg x 50g 1500 kg x 100g		600 kg x 100g 1500 kg x 200g		600 kg x 100 / 200g 1500 kg x 200 / 500g		600 kg x 200g 1500 kg x 500g	
KAPASİTE	Boyut	L/C	Tip	Cins	DW	CW	HWP-ET	SPW	RCW	ABM				
					N	L	N		A					
600 kg	90 x 100 cm	KLC	1D	B	2.370,00	2.440,00	3.400,00	7.195,00	2.670,00	3.085,00				
		BLC			2.745,00	2.815,00	3.775,00	7.570,00	3.045,00	3.460,00				
	100 x 100 cm	BLC			2.945,00	3.015,00	3.975,00	7.770,00	3.245,00	3.660,00				
	100 x 110 cm	BLC			3.190,00	3.260,00	4.220,00	8.015,00	3.490,00	3.905,00				
	100 x 120 cm				3.225,00	3.295,00	4.255,00	8.050,00	3.525,00	3.940,00				
	120 x 120 cm				3.265,00	3.335,00	4.295,00	8.090,00	3.565,00	3.980,00				
750 kg	110 x 80 cm	KLC	1D	B	2.750,00	2.820,00	3.780,00	7.575,00	3.050,00	3.465,00				
1000 kg	110 x 80 cm	BLC	1D	B	2.965,00	3.035,00	3.995,00	7.790,00	3.265,00	3.680,00				
1500 kg	90 x 100 cm	BLC	1D	B	2.865,00	2.935,00	3.895,00	7.690,00	3.165,00	3.580,00				
	100 x 100 cm				3.025,00	3.095,00	4.055,00	7.850,00	3.325,00	3.740,00				
	100 x 110 cm				3.280,00	3.350,00	4.310,00	8.105,00	3.580,00	3.995,00				
	100 x 120 cm				3.320,00	3.390,00	4.350,00	8.145,00	3.620,00	4.035,00				
	120 x 120 cm				3.890,00	3.960,00	4.920,00	8.715,00	4.190,00	4.605,00				

\* İtme kolu ve tekerlek farkı;

600 kg - 750 kg için 900 TL + KDV

1000 kg - 1500 kg için 1000 TL + KDV

**DW****CW****RCW****ABM****RXC**

opsiyonel: LCD gösterge



kablosuz iletişim



1D platform

**Opsiyonlar :**

RS-232 Bağlantısı için 110,00 TL + KDV fiyata ilave edilir; modeller CW, EW, RCW, REW, ABM, ATM



Bluetooth Bağlantısı için 210,00 TL + KDV fiyata ilave edilir; modeller RCW, REW, ABM, ATM

Harici Gösterge RXC modeli için 750,00 TL + KDV fiyata ilave edilir

## BASKÜL TANIMLARI

### Tek Yük Hücreli Basküllerin Tanımlanma Sistemi

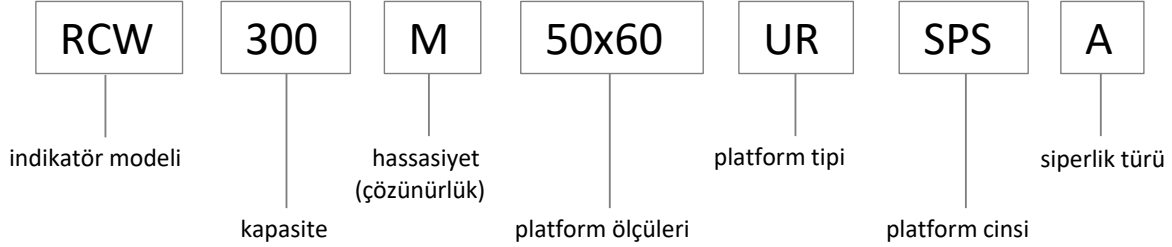

HASSASİYET	
<b>A</b>	: 1/3.000 Ticari Onaylı
<b>L</b>	: 1 / 15.000
<b>M</b>	: 1 / 30.000
<b>H</b>	: 1 / 60.000
<b>S1</b>	: 1 / 100.000

PLATFORM TİPİ	
<b>D</b>	: Tek Yük Hüc. Klasik Model
<b>E</b>	: Tek Yük Hüc. Eko Model
<b>UR</b>	: Tek Yük Hüc (Köşe Yuvarlak)
<b>LAR</b>	: Tek Yük Hüc Alümin Gövde
<b>LUR</b>	: Tek Yük Hüc Alümin Gövde

PLATFORM CİNSİ	
<b>B</b>	: Elektro Statik Fırın Boyalı
<b>S</b>	: Paslanmaz Tabla
<b>SBS</b>	: Paslanmaz Tabla, Boyalı Siperlik
<b>SPS</b>	: Paslanmaz Tabla, Paslanmaz Siperlik
<b>SX</b>	: Paslanmaz Gövde (Loadcell Alüminyum )
<b>SS</b>	: Paslanmaz Gövde ve Paslanmaz Loadcell

### Dört Yük Hücreli Basküllerin Tanımlanma Sistemi

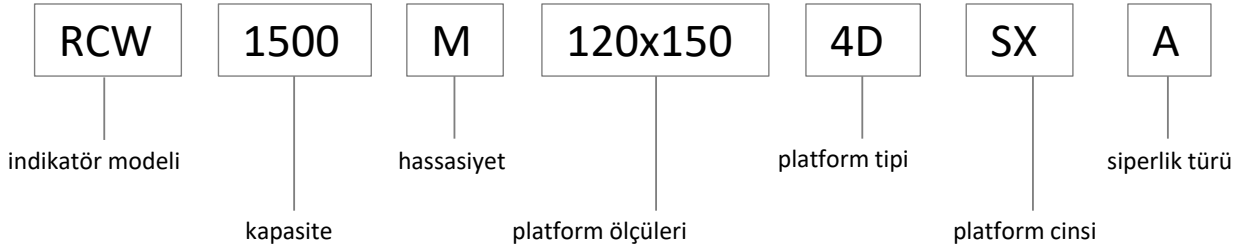

AĞIR ÇEKERLİ BASKÜL TİP TANIMLAMALARI ;	
<b>4D</b>	: Dört Yük Hücreli ve Çift Çerçevesi Platform
<b>4L</b>	: Dört Yük Hücreli ve Tek Çerçevesi Platform
<b>4MB</b>	: Dört Yük Hücreli ve Mono Blok Platform
<b>4SB</b>	: Dört Yük Hücreli ve Slim Blok Platform
<b>E</b>	: Elektromekanik Platform
<b>4U</b>	: Dört Yük Hücreli ve U-tipi Platform
<b>4BK</b>	: Dört Yük Hücreli ve U-tipi Platformlu Blok Kantarı
<b>LPDR</b>	: Dört Yük Hücreli ve alçak tabanlı , Kendinden Rampalı Platform
<b>LP</b>	: Dört Yük Hücreli ve Alçak tabanlı Platform
<b>4P</b>	: Dört Yük Hücreli ve Alçak Tabanlı Platform

PLATFORM CİNSİ	
<b>B</b>	: Elektro Statik Fırın Boyalı
<b>S</b>	: Paslanmaz Tabla
<b>SBS</b>	: Paslanmaz Tabla , Boyalı Siperlik
<b>SPS</b>	: Paslanmaz Tabla , Paslanmaz Siperlik
<b>SX</b>	: Paslanmaz Gövde (Load cell Alüminyum )
<b>SS</b>	: Paslanmaz Gövde ve Paslanmaz Load cell

## FIYAT LİSTESİ

05.04.2021  
www.dikomsan.com

				4 LOADCELL - TEK ŞASE - TARTIM BASKÜLLERİ MONOBLOK						
				Fiş Yazıcılı		Etiket Yazıcılı		M		
Kapasite	Tip	Cins	Boyut	CW	HWP-ET	FB-530	HWP-CL	SPW	RCW	ABM
1 / 6 000				1 / 6 000	1 / 6 000	1 / 6 000	1 / 6 000	1 / 6 000	Çift Taksimat 1 / 3 000	Çift Taksimat 1 / 3 000
600 kg	4MB	B	100 x 100 cm	3.480,00	4.440,00	4.465,00	4.865,00	8.235,00	3.710,00	3.980,00
1500 kg			100 x 120 cm	3.615,00	4.575,00	4.600,00	5.000,00	8.370,00	3.845,00	4.115,00
2000 kg			120 x 120 cm	3.780,00	4.740,00	4.765,00	5.165,00	8.535,00	4.010,00	4.280,00
			120 x 150 cm	4.070,00	5.030,00	5.055,00	5.455,00	8.825,00	4.300,00	4.570,00
			120 x 200 cm	4.405,00	5.365,00	5.390,00	5.790,00	9.160,00	4.635,00	4.905,00
			150 x 150 cm	4.155,00	5.115,00	5.140,00	5.540,00	8.910,00	4.385,00	4.655,00
			150 x 200 cm	4.535,00	5.495,00	5.520,00	5.920,00	9.290,00	4.765,00	5.035,00



<b>SLİMBLOK (İNCE)</b> <b>4SB</b>				Yazıcılı İndikatörler					TİCARİ KULLANIM			
				Fiş Yazıcılı		Etiket Yazıcılı			Paslanmaz İndikatör			
Kapasite	Tip	Cins	Boyut	EW	HWP-ET	FB-530	HWP-CL	SPW	REW	RHW	RSW	APS
1 / 6 000				1 / 6 000	1 / 6 000	1 / 6 000	1 / 6 000	1 / 6 000	Çift Taksimat 1 / 3 000	Çift Taksimat 1 / 3 000	1 / 6 000	1 / 6 000
150 kg	4SB	B	60 x 80 cm	2.995,00	3.955,00	3.980,00	4.380,00	7.750,00	3.225,00	3.495,00	3.675,00	2.560,00
				4.120,00	5.080,00	5.105,00	5.505,00	8.875,00	4.350,00	4.620,00	4.800,00	3.685,00
				6.205,00	7.165,00	7.190,00	7.590,00	10.960,00	6.435,00	6.705,00	6.885,00	5.770,00
300 kg	4SB	SX	80 x 90 cm	3.270,00	4.230,00	4.255,00	4.655,00	8.025,00	3.500,00	3.770,00	3.950,00	2.835,00
				4.505,00	5.465,00	5.490,00	5.890,00	9.260,00	4.735,00	5.005,00	5.185,00	4.070,00
				6.590,00	7.550,00	7.575,00	7.975,00	11.345,00	6.820,00	7.090,00	7.270,00	6.155,00
600 kg	4SB	SS	100 x 110 cm	3.380,00	4.340,00	4.365,00	4.765,00	8.135,00	3.610,00	3.880,00	4.060,00	2.945,00
				5.605,00	6.565,00	6.590,00	6.990,00	10.360,00	5.835,00	6.105,00	6.285,00	5.170,00
				7.690,00	8.650,00	8.675,00	9.075,00	12.445,00	7.920,00	8.190,00	8.370,00	7.255,00
1500 kg	4SB	B	100 x 110 cm	3.420,00	4.380,00	4.405,00	4.805,00	8.175,00	3.650,00	3.920,00	4.100,00	2.985,00
				5.795,00	6.755,00	6.780,00	7.180,00	10.550,00	6.025,00	6.295,00	6.475,00	5.360,00
				7.885,00	8.845,00	8.870,00	9.270,00	12.640,00	8.115,00	8.385,00	8.565,00	7.450,00



NOT : Bu modellerde siperlik opsiyoneldir ve fiyatlara dahil değildir.

# FİYAT LİSTESİ

05.04.2021

www.dikomsan.com

				4 LOADCELL - TEK ŞASE - TARTIM BASKÜLLERİ					4L	
				CW	Fiş Yazıcılı		Etiket Yazıcılı		M	
L	HWP-ET	FB-530	HWP-CL		SPW	RCW	ABM			
	Kapasite	Tip	Cins	Boyut	L					A
600 kg	4L	B	100 x 100 cm	3.560,00	4.780,00	4.910,00	5.160,00	8.730,00	4.005,00	4.420,00
			100 x 120 cm	3.630,00	4.850,00	4.980,00	5.230,00	8.800,00	4.075,00	4.490,00
			100 x 200 cm	4.400,00	5.620,00	5.750,00	6.000,00	9.570,00	4.845,00	5.260,00
			120 x 120 cm	3.600,00	4.820,00	4.950,00	5.200,00	8.770,00	4.045,00	4.460,00
			120 x 150 cm	4.110,00	5.330,00	5.460,00	5.710,00	9.280,00	4.555,00	4.970,00
			120 x 200 cm	4.470,00	5.690,00	5.820,00	6.070,00	9.640,00	4.915,00	5.330,00
			150 x 150 cm	4.220,00	5.440,00	5.570,00	5.820,00	9.390,00	4.665,00	5.080,00
1500 kg	4L	B	100 x 100 cm	3.560,00	4.780,00	4.910,00	5.160,00	8.730,00	4.005,00	4.420,00
			100 x 120 cm	3.670,00	4.890,00	5.020,00	5.270,00	8.840,00	4.115,00	4.530,00
			100 x 200 cm	4.550,00	5.770,00	5.900,00	6.150,00	9.720,00	4.995,00	5.410,00
			120 x 120 cm	3.730,00	4.950,00	5.080,00	5.330,00	8.900,00	4.175,00	4.590,00
			120 x 150 cm	4.170,00	5.390,00	5.520,00	5.770,00	9.340,00	4.615,00	5.030,00
			120 x 200 cm	4.710,00	5.930,00	6.060,00	6.310,00	9.880,00	5.155,00	5.570,00
			150 x 150 cm	4.600,00	5.820,00	5.950,00	6.200,00	9.770,00	5.045,00	5.460,00
			150 x 200 cm	5.360,00	6.580,00	6.710,00	6.960,00	10.530,00	5.805,00	6.220,00
			200 x 200 cm	6.250,00	7.470,00	7.600,00	7.850,00	11.420,00	6.695,00	7.110,00
3000 kg	4L	B	100 x 100 cm	3.740,00	4.960,00	5.090,00	5.340,00	8.910,00	4.185,00	4.600,00
			120 x 120 cm	4.370,00	5.590,00	5.720,00	5.970,00	9.540,00	4.815,00	5.230,00
			120 x 150 cm	4.610,00	5.830,00	5.960,00	6.210,00	9.780,00	5.055,00	5.470,00
			120 x 200 cm	5.670,00	6.890,00	7.020,00	7.270,00	10.840,00	6.115,00	6.530,00
			150 x 150 cm	5.240,00	6.460,00	6.590,00	6.840,00	10.410,00	5.685,00	6.100,00
			150 x 200 cm	6.450,00	7.670,00	7.800,00	8.050,00	11.620,00	6.895,00	7.310,00
			200 x 200 cm	6.590,00	7.810,00	7.940,00	8.190,00	11.760,00	7.035,00	7.450,00
6000 kg	4L	B	100 x 100 cm	6.490,00	7.710,00	7.840,00	8.090,00	11.660,00	6.935,00	7.350,00
			120 x 120 cm	7.050,00	8.270,00	8.400,00	8.650,00	12.220,00	7.495,00	7.910,00
			120 x 150 cm	7.330,00	8.550,00	8.680,00	8.930,00	12.500,00	7.775,00	8.190,00
			120 x 200 cm	9.010,00	10.230,00	10.360,00	10.610,00	14.180,00	9.455,00	9.870,00
			150 x 150 cm	8.970,00	10.190,00	10.320,00	10.570,00	14.140,00	9.415,00	9.830,00
			150 x 200 cm	9.230,00	10.450,00	10.580,00	10.830,00	14.400,00	9.675,00	10.090,00
			200 x 200 cm	11.830,00	13.050,00	13.180,00	13.430,00	17.000,00	12.275,00	12.690,00
10000 kg	4L	B	120 x 120 cm	11.020,00	12.240,00	12.370,00	12.620,00	16.190,00	11.465,00	11.880,00
			120 x 150 cm	11.550,00	12.770,00	12.900,00	13.150,00	16.720,00	11.995,00	12.410,00
			120 x 200 cm	13.140,00	14.360,00	14.490,00	14.740,00	18.310,00	13.585,00	14.000,00

**NOT :** RS-232 bağlantısı için yukarıdaki baskül fiyatlarına + 115.00 TL ilave edilecektir.

Bu modellerde siperlik opsiyoneldir ve fiyatlara dahil değildir.

# FIYAT LİSTESİ

05.04.2021  
www.dikomsan.com



## 4 LOADCELL - TEK ŞASE - TARTIM BASKÜLLERİ

4L

Kapasite	Tip	Cins	Boyut	4L				M		
				CW	Fiş Yazıclı		Etiket Yazıclı		RCW	RSW
				L	L				A	
					HWP-ET	FB-530	HWP-CL	SPW		
600 Kg	4L	S	100 x 100 cm	6.135,00	7095,00	7270,00	7520,00	11090,00	6.365,00	6.720,00
				8.005,00	8965,00	9140,00	9390,00	12960,00	8.235,00	8.590,00
		SX	100 x 120 cm	6.495,00	7455,00	7630,00	7880,00	11450,00	6.725,00	7.080,00
				10.125,00	11085,00	11260,00	11510,00	15080,00	10.355,00	10.710,00
		S	120 x 120 cm	7.075,00	8035,00	8210,00	8460,00	12030,00	7.305,00	7.660,00
				10.565,00	11525,00	11700,00	11950,00	15520,00	10.795,00	11.150,00
		SX	120 x 150 cm	8.395,00	9355,00	9530,00	9780,00	13350,00	8.625,00	8.980,00
				11.195,00	12.155,00	12.330,00	12.580,00	16.150,00	11.425,00	11.780,00
		S	120 x 200 cm	11.555,00	12.515,00	12.690,00	12.940,00	16.510,00	11.785,00	12.140,00
				18.695,00	19.655,00	19.830,00	20.080,00	23.650,00	18.925,00	19.280,00
		SX	150 x 150 cm	9.835,00	10.795,00	10.970,00	11.220,00	14.790,00	10.065,00	10.420,00
				14.495,00	15.455,00	15.630,00	15.880,00	19.450,00	14.725,00	15.080,00
1500 Kg	4L	S	100 x 100 cm	6.365,00	7.325,00	7.500,00	7.750,00	11.320,00	6.595,00	6.950,00
				9.285,00	10.245,00	10.420,00	10.670,00	14.240,00	9.515,00	9.870,00
		SX	100 x 120 cm	7.625,00	8.585,00	8.760,00	9.010,00	12.580,00	7.855,00	8.210,00
				10.735,00	11.695,00	11.870,00	12.120,00	15.690,00	10.965,00	11.320,00
		S	100 x 200 cm	8.715,00	9.675,00	9.850,00	10.100,00	13.670,00	8.945,00	9.300,00
				14.155,00	15.115,00	15.290,00	15.540,00	19.110,00	14.385,00	14.740,00
		SX	120 x 120 cm	7.635,00	8.595,00	8.770,00	9.020,00	12.590,00	7.865,00	8.220,00
				11.185,00	12.145,00	12.320,00	12.570,00	16.140,00	11.415,00	11.770,00
		S	120 x 150 cm	8.825,00	9.785,00	9.960,00	10.210,00	13.780,00	9.055,00	9.410,00
				12.495,00	13.455,00	13.630,00	13.880,00	17.450,00	12.725,00	13.080,00
		SX	120 x 200 cm	11.825,00	12.785,00	12.960,00	13.210,00	16.780,00	12.055,00	12.410,00
				18.825,00	19.785,00	19.960,00	20.210,00	23.780,00	19.055,00	19.410,00
S	150 x 150 cm	10.005,00	10.965,00	11.140,00	11.390,00	14.960,00	10.235,00	10.590,00		
		16.225,00	17.185,00	17.360,00	17.610,00	21.180,00	16.455,00	16.810,00		
SX	150 x 200 cm	12.015,00	12.975,00	13.150,00	13.400,00	16.970,00	12.245,00	12.600,00		
		19.505,00	20.465,00	20.640,00	20.890,00	24.460,00	19.735,00	20.090,00		
3000 Kg	4L	S	100 x 100 cm	6.945,00	7.905,00	8.080,00	8.330,00	11.900,00	7.175,00	7.530,00
				10.775,00	11.735,00	11.910,00	12.160,00	15.730,00	11.005,00	11.360,00
		SX	120 x 120 cm	8.435,00	9.395,00	9.570,00	9.820,00	13.390,00	8.665,00	9.020,00
				13.035,00	13.995,00	14.170,00	14.420,00	17.990,00	13.265,00	13.620,00
		S	120 x 150 cm	9.635,00	10.595,00	10.770,00	11.020,00	14.590,00	9.865,00	10.220,00
				14.465,00	15.425,00	15.600,00	15.850,00	19.420,00	14.695,00	15.050,00
		SX	120 x 200 cm	14.485,00	15.445,00	15.620,00	15.870,00	19.440,00	14.715,00	15.070,00
				22.315,00	23.275,00	23.450,00	23.700,00	27.270,00	22.545,00	22.900,00
		S	150 x 150 cm	12.275,00	13.235,00	13.410,00	13.660,00	17.230,00	12.505,00	12.860,00
				18.425,00	19.385,00	19.560,00	19.810,00	23.380,00	18.655,00	19.010,00
		SX	150 x 200 cm	14.515,00	15.475,00	15.650,00	15.900,00	19.470,00	14.745,00	15.100,00
				22.585,00	23.545,00	23.720,00	23.970,00	27.540,00	22.815,00	23.170,00

**NOT :**

RS-232 bağlantısı için yukarıdaki baskül fiyatlarına + 115.00 TL ilave edilecektir.

Max 3 ton dahil basküllerde paslanmaz loadcell istenirse farkı fiyata ilave edilecektir.

# FİYAT LİSTESİ

05.04.2021

www.dikomsan.com

				4 LOADCELL - ÇİFT ŞASE - TARTIM BASKÜLLERİ								4D		
				CW		Fiş Yazıcılı		Etiket Yazıcılı		M				
Kapasite	Tip	Cins	Boyut	L	HWP-ET	FB-530	HWP-CL	SPW	RCW	RMW	ABM			
				L	L		L		A					
600 kg	4D	B	100 x 100 cm	5.565,00	6.570,00	6.700,00	6.950,00	10.520,00	5.795,00	5.850,00	6.210,00			
			120 x 120 cm	5.675,00	6.680,00	6.810,00	7.060,00	10.630,00	5.905,00	5.960,00	6.320,00			
			120 x 150 cm	6.115,00	7.120,00	7.250,00	7.500,00	11.070,00	6.345,00	6.400,00	6.760,00			
1500 kg	4D	B	100 x 100 cm	5.710,00	6.715,00	6.845,00	7.095,00	10.665,00	5.940,00	5.995,00	6.355,00			
			120 x 120 cm	5.815,00	6.820,00	6.950,00	7.200,00	10.770,00	6.045,00	6.100,00	6.460,00			
			120 x 150 cm	6.200,00	7.205,00	7.335,00	7.585,00	11.155,00	6.430,00	6.485,00	6.845,00			
			120 x 200 cm	7.215,00	8.220,00	8.350,00	8.600,00	12.170,00	7.445,00	7.500,00	7.860,00			
			150 x 150 cm	6.760,00	7.765,00	7.895,00	8.145,00	11.715,00	6.990,00	7.045,00	7.405,00			
			150 x 200 cm	7.900,00	8.905,00	9.035,00	9.285,00	12.855,00	8.130,00	8.185,00	8.545,00			
			200 x 200 cm	9.965,00	10.970,00	11.100,00	11.350,00	14.920,00	10.195,00	10.250,00	10.610,00			
3000 kg	4D	B	100 x 100 cm	5.820,00	6.825,00	6.955,00	7.205,00	10.775,00	6.050,00	6.105,00	6.465,00			
			120 x 120 cm	6.060,00	7.065,00	7.195,00	7.445,00	11.015,00	6.290,00	6.345,00	6.705,00			
			120 x 150 cm	6.440,00	7.445,00	7.575,00	7.825,00	11.395,00	6.670,00	6.725,00	7.085,00			
			120 x 200 cm	7.505,00	8.510,00	8.640,00	8.890,00	12.460,00	7.735,00	7.790,00	8.150,00			
			150 x 150 cm	7.035,00	8.040,00	8.170,00	8.420,00	11.990,00	7.265,00	7.320,00	7.680,00			
			150 x 200 cm	8.030,00	9.035,00	9.165,00	9.415,00	12.985,00	8.260,00	8.315,00	8.675,00			
			200 x 200 cm	10.865,00	11.870,00	12.000,00	12.250,00	15.820,00	11.095,00	11.150,00	11.510,00			
6000 kg	4D	B	100 x 100 cm	12.690,00	13.695,00	13.825,00	14.075,00	17.645,00	12.920,00	12.975,00	13.335,00			
			120 x 120 cm	13.420,00	14.425,00	14.555,00	14.805,00	18.375,00	13.650,00	13.705,00	14.065,00			
			120 x 150 cm	14.075,00	15.080,00	15.210,00	15.460,00	19.030,00	14.305,00	14.360,00	14.720,00			
			120 x 200 cm	13.585,00	14.590,00	14.720,00	14.970,00	18.540,00	13.815,00	13.870,00	14.230,00			
			150 x 150 cm	14.330,00	15.335,00	15.465,00	15.715,00	19.285,00	14.560,00	14.615,00	14.975,00			
			150 x 200 cm	15.820,00	16.825,00	16.955,00	17.205,00	20.775,00	16.050,00	16.105,00	16.465,00			
			200 x 200 cm	19.080,00	20.085,00	20.215,00	20.465,00	24.035,00	19.310,00	19.365,00	19.725,00			
10000 kg	4D	B	150 x 200 cm	17.825,00	18.830,00	18.960,00	19.210,00	22.780,00	18.055,00	18.110,00	18.470,00			

**NOT :** RS-232 bağlantısı için yukarıdaki baskül fiyatlarına + 115,00 TL ilave edilecektir.

Bu modellerde sipariş opsiyoneldir ve fiyatlara dahil değildir.



DÖRT YÜK HÜCRELİ (4 LOAD CELL ) ÇİFT ŞASE (4D) PLATFORMLARDA YÜKSEK HASSASİYET					<b>BÜYÜK PLATFORM HASSAS BASKÜLLER</b>	
Platformlar					DJB (digital JB) ve RD-DOT Gösterge	
KAPASİTE	Tip	Cins	Boyut		<b>1 / 30.000</b>	
600 kg	4D	B	100 x 100 cm	<b>600 kg x 20 g</b>	6.785,00	
		S			11.465,00	
		B	120 x 120 cm		6.895,00	
		S			13.050,00	
		B	120 x 150 cm		7.335,00	
		S			13.320,00	
1500 kg	4D	B	100 x 100 cm	<b>1.500 kg x 50 g</b>	9.440,00	
		S			17.835,00	
		B	120 x 120 cm		6.930,00	
		S			11.635,00	
		B	120 x 150 cm		7.035,00	
		S			13.295,00	
3000 kg	4D	B	100 x 100 cm	<b>3.000 kg x 100 g</b>	7.420,00	
		S			13.600,00	
		B	120 x 120 cm		9.120,00	
		S			17.735,00	
		B	120 x 150 cm		7.090,00	
		S			11.775,00	
		B	150 x 200 cm		7.330,00	
		S			13.790,00	
		B	120 x 150 cm		7.710,00	
		S			14.120,00	
		B	150 x 200 cm		9.300,00	
		S			19.730,00	

**Digital Junction Box**

Dört Loadcell'li sistemlerde yüksek hassasiyet

**Dört Ayrı Platform veya Altı Ayrı Platform Bağlanarak Bilgisayar veya RD-DOT display ile görüntülenebilir  
DJB Paslanmaz (SS) kutu haznesi içinde yer almaktadır**

**ÖZEL BASKÜL VE PLATFORM ÇEŞİTLERİ**

DÖRT YÜK HÜCRELİ ALÇAK TABAN TEK ŞASE LP					TARTIM BASKÜLLERİ					
					ENDÜSTRİYEL KULLANIM		TİCARİ KULLANIM			
					EW	Fiş Yazıcılı	REW	AFM-18	Paslanmaz İndikator	
									RCW	AFM-18
Kapasite	Taksimat	TİP	Cins	Boyut	CW	HWP-ET	RCW	AFM-18	RHW	RSW
300 kg	100 g	LP	B	100 x 120 cm (10+80+10) x (120)	3.830,00	4.790,00	4.060,00	4.475,00	4.330,00	4.515,00
			SX		6.660,00	7.620,00	6.890,00	7.305,00	7.160,00	7.345,00
			B	120 x 120 cm (10+100+10) x (120)	3.845,00	4.805,00	4.075,00	4.490,00	4.345,00	4.530,00
			SX		6.785,00	7.745,00	7.015,00	7.430,00	7.285,00	7.470,00
600 kg	200 g	LP	B	100 x 120 cm (10+80+10) x (120)	3.955,00	4.915,00	4.185,00	4.600,00	4.455,00	4.640,00
			SX		7.045,00	8.005,00	7.275,00	7.690,00	7.545,00	7.730,00
			B	100 x 150 cm (10+80+10) x (150)	4.145,00	5.105,00	4.375,00	4.790,00	4.645,00	4.830,00
			SX		7.660,00	8.620,00	7.890,00	8.305,00	8.160,00	8.345,00
			B	120 x 120 cm (10+100+10) x (120)	3.980,00	4.940,00	4.210,00	4.625,00	4.480,00	4.665,00
			SX		7.245,00	8.205,00	7.475,00	7.890,00	7.745,00	7.930,00
			B	120 x 150 cm (10+100+10) x (150)	4.330,00	5.290,00	4.560,00	4.975,00	4.830,00	5.015,00
			SX		8.930,00	9.890,00	9.160,00	9.575,00	9.430,00	9.615,00
1000 kg 1500 kg	200 g	LP	B	100 x 120 cm (10+80+10) x (120)	4.390,00	5.350,00	4.620,00	5.035,00	4.890,00	5.075,00
			SX		8.750,00	9.710,00	8.980,00	9.395,00	9.250,00	9.435,00
			B	100 x 150 cm (10+80+10) x (150)	4.595,00	5.555,00	4.825,00	5.240,00	5.095,00	5.280,00
			SX		9.430,00	10.390,00	9.660,00	10.075,00	9.930,00	10.115,00
			B	120 x 120 cm (10+100+10) x (120)	4.445,00	5.405,00	4.675,00	5.090,00	4.945,00	5.130,00
			SX		9.400,00	10.360,00	9.630,00	10.045,00	9.900,00	10.085,00
			B	120 x 150 cm (10+100+10) x (150)	4.815,00	5.775,00	5.045,00	5.460,00	5.315,00	5.500,00
			SX		10.930,00	11.890,00	11.160,00	11.575,00	11.430,00	11.615,00
	500 g	LP	B	120 x 200 cm (10+100+10) x (200)	5.425,00	6.385,00	5.655,00	6.070,00	5.925,00	6.110,00
			SX		13.180,00	14.140,00	13.410,00	13.825,00	13.680,00	13.865,00
			B	150 x 150 cm (10+130+10) x (150)	5.120,00	6.080,00	5.350,00	5.765,00	5.620,00	5.805,00
			SX		12.145,00	13.105,00	12.375,00	12.790,00	12.645,00	12.830,00
			B	150 x 200 cm (10+130+10) x (200)	5.760,00	6.720,00	5.990,00	6.405,00	6.260,00	6.445,00
			SX		14.595,00	15.555,00	14.825,00	15.240,00	15.095,00	15.280,00
			B	120 x 120 cm (10+100+10) x (120)	5.100,00	6.060,00	5.330,00	5.745,00	5.600,00	5.785,00
			SX		11.590,00	12.550,00	11.820,00	12.235,00	12.090,00	12.275,00
2000 kg	1000 g	LP	B	120 x 150 cm (10+100+10) x (150)	5.630,00	6.590,00	5.860,00	6.275,00	6.130,00	6.315,00
			SX		11.350,00	12.310,00	11.580,00	11.995,00	11.850,00	12.035,00
			B	120 x 200 cm (10+100+10) x (200)	6.390,00	7.350,00	6.620,00	7.035,00	6.890,00	7.075,00
			SX		16.635,00	17.595,00	16.865,00	17.280,00	17.135,00	17.320,00
			B	150 x 150 cm (10+130+10) x (150)	5.995,00	6.955,00	6.225,00	6.640,00	6.495,00	6.680,00
			SX		15.145,00	16.105,00	15.375,00	15.790,00	15.645,00	15.830,00
			B	150 x 200 cm (10+130+10) x (200)	6.795,00	7.755,00	7.025,00	7.440,00	7.295,00	7.480,00
			SX		18.365,00	19.325,00	18.595,00	19.010,00	18.865,00	19.050,00

Not: Rampa fiyatları yukarıdaki fiyatlara dahil değildir. Rampa fiyatı bir veya iki adet olarak eklenmelidir.

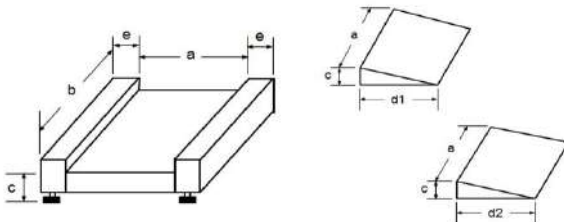

LP	a	b	c	d1	d2	e
100 X 120	80 cm	120 cm	6.5 cm	45 cm	70 cm	10 cm
100 X 150	80 cm	150 cm	6.5 cm	45 cm	70 cm	10 cm
120 X 120	100 cm	120 cm	6.5 cm	45 cm	70 cm	10 cm
120 X 150	100 cm	150 cm	6.5 cm	45 cm	70 cm	10 cm
120 X 200	100 cm	200 cm	6.5 cm	45 cm	70 cm	10 cm
150 X 150	130 cm	150 cm	6.5 cm	45 cm	70 cm	10 cm
150 X 200	130 cm	200 cm	6.5 cm	45 cm	70 cm	10 cm

## ÖZEL BASKÜL VE PLATFORM ÇEŞİTLERİ

DÖRT YÜK HÜCRELİ KENDİNDEN RAMPALI - TEK ŞASE LPDR					GİRİŞ		TARTIM BASKÜLLERİ				
							ENDÜSTRİYEL KULLANIM		TİCARİ KULLANIM		
Kapasite	Taksimat	TİP	Cins	Boyut	EW	CW	Yazıcı	REW	ABM	Paslanmaz İndikator	
							HWP-ET			RHW	RSW
300 kg	100 g	LPDR	B	120 x 120 cm (10+100+10) x (20+80+20)	4.290,00	5.250,00		4.520,00	4.935,00	4.790,00	4.975,00
			SX		7.250,00	8.210,00	7.480,00	7.895,00	7.750,00	7.935,00	
600 kg	200 g	LPDR	B	120 x 150 cm (10+100+10) x (20+110+20)	4.680,00	5.640,00		4.910,00	5.325,00	5.180,00	5.365,00
			SX		9.410,00	10.370,00	9.640,00	10.055,00	9.910,00	10.095,00	
			B	140 x 200 cm 10+120+10 , 20+160+20	5.345,00	6.305,00	5.575,00	5.990,00	5.845,00	6.030,00	
			SX		11.955,00	12.915,00	12.185,00	12.600,00	12.455,00	12.640,00	
1000 kg 1500 kg	200 g	LPDR	B	120 x 150 cm 10+100+10 , 20+110+20	4.925,00	5.885,00		5.155,00	5.570,00	5.425,00	5.610,00
			SX		11.370,00	12.330,00	11.600,00	12.015,00	11.870,00	12.055,00	
	B	120 x 200 cm 10+100+10 , 20+160+20	5.300,00	6.260,00	5.530,00	5.945,00	5.800,00	5.985,00			
	SX		11.455,00	12.415,00	11.685,00	12.100,00	11.955,00	12.140,00			
	B	120 x 240 cm 10+100+10 , 20+200+20	5.855,00	6.815,00	6.085,00	6.500,00	6.355,00	6.540,00			
	SX		14.685,00	15.645,00	14.915,00	15.330,00	15.185,00	15.370,00			
	B	140 x 240 cm 10+120+10 , 20+200+20	5.885,00	6.845,00	6.115,00	6.530,00	6.385,00	6.570,00			
	SX		14.790,00	15.750,00	15.020,00	15.435,00	15.290,00	15.475,00			
2000 kg	1000 g	LPDR	B	120 x 240 cm 10+100+10 , 20+200+20	6.355,00	7.315,00		6.585,00	7.000,00	6.855,00	7.040,00
			SX		15.185,00	16.145,00	15.415,00	15.830,00	15.685,00	15.870,00	
			B	140 x 240 cm 10+120+10 , 20+200+20	6.385,00	7.345,00	6.615,00	7.030,00	6.885,00	7.070,00	
			SX		15.290,00	16.250,00	15.520,00	15.935,00	15.790,00	15.975,00	

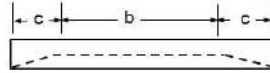
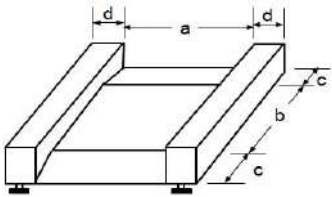

LP	a	b	c	d
100 X 150	80 cm	110 cm	20 cm	10 cm
120 X 120	100 cm	80 cm	20 cm	10 cm
120 X 150	100 cm	110 cm	20 cm	10 cm
120 X 200	100 cm	160 cm	20 cm	10 cm
120 X 240	100 cm	200 cm	20 cm	10 cm
140 X 240	120 cm	200 cm	20 cm	10 cm





DÖRT YÜK HÜCRELİ ( 4 Load Cell ) TEK ŞASE <b>DM</b> PLATFORMLAR				TARTIM BASKÜLLERİ							
				ENDÜSTRİYEL KULLANIM			TİCARİ KULLANIM				
				Yazıcılı indikator			REW				
				ASB	FB-530	SPW	RCW	RMW	ABM	ATM	
Kapasite	Tip	Cins	Boyut								
1,5 t	DM		100 x 120 cm	5.490,00	6.300,00	10.120,00	5.395,00	5.450,00	5.810,00	5.800,00	
			100 x 200 cm	6.670,00	7.480,00	11.300,00	6.575,00	6.630,00	6.990,00	6.980,00	
			120 x 200 cm	6.830,00	7.640,00	11.460,00	6.735,00	6.790,00	7.150,00	7.140,00	
			150 x 200 cm	7.530,00	8.340,00	12.160,00	7.435,00	7.490,00	7.850,00	7.840,00	
3 t	DM		100 x 120 cm	6.170,00	6.980,00	10.800,00	6.075,00	6.130,00	6.490,00	6.480,00	
			100 x 200 cm	7.640,00	8.450,00	12.270,00	7.545,00	7.600,00	7.960,00	7.950,00	
			120 x 200 cm	7.790,00	8.600,00	12.420,00	7.695,00	7.750,00	8.110,00	8.100,00	
			150 x 200 cm	8.620,00	9.430,00	13.250,00	8.525,00	8.580,00	8.940,00	8.930,00	
6 t	DM		100 x 120 cm	8.960,00	9.770,00	13.590,00	8.865,00	8.920,00	9.280,00	9.270,00	
			100 x 200 cm	11.145,00	11.955,00	15.775,00	11.050,00	11.105,00	11.465,00	11.455,00	
			120 x 200 cm	11.295,00	12.105,00	15.925,00	11.200,00	11.255,00	11.615,00	11.605,00	
			150 x 200 cm	11.515,00	12.325,00	16.145,00	11.420,00	11.475,00	11.835,00	11.825,00	
10 t	DM		120 x 120 cm	12.020,00	12.830,00	16.650,00	11.925,00	11.980,00	12.340,00	12.330,00	
			120 x 150 cm	12.710,00	13.520,00	17.340,00	12.615,00	12.670,00	13.030,00	13.020,00	
			120 x 200 cm	14.330,00	15.140,00	18.960,00	14.235,00	14.290,00	14.650,00	14.640,00	
			150 x 200 cm	15.190,00	16.000,00	19.820,00	15.095,00	15.150,00	15.510,00	15.500,00	

NOT 1 : RS-232 bağlantısı için yukarıdaki baskül fiyatlarına + 115.00 TL ilave edilecektir.

NOT 1 : Demirci basküllerinde sehpa ve üst parçalar yukarıdaki fiyatlara dahildir . h= 80 cm



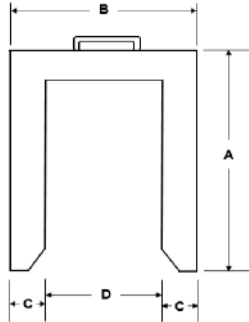



## U - Tipi Palet Basküller

Model	Kod	Kapasite	Taksimat	FİYAT (TL)																								
<b>U - RCW-1500</b>  	Fiyatlar <b>RCW</b> indikartörlü olarak verilmiştir.			<b>Elektro Statik Fırın Boyalı</b>	<b>Komple Paslanmaz Gövde</b>																							
				<b>B</b>	<b>SX</b>																							
	600 kg	200 g	<b>120 x 80 cm</b> Çatal arası : 60 cm h=8,5 cm NPU=100	<b>2.860,00</b>	<b>6.820,00</b>																							
	1000 kg	500 g			<b>7.020,00</b>																							
	600 kg	200 g	<b>120 x 84 cm</b> Çatal arası : 60 cm h=9 cm NPU=120	<b>3.820,00</b>	<b>6.985,00</b>																							
	1500 kg	500 g			<b>7.890,00</b>																							
	3000 kg	1000 g			<b>11.135,00</b>																							
	1500 kg	500 g	<b>120 x 109 cm</b> Çatal arası : 85 cm h=9 cm NPU=120	<b>3.925,00</b>	-																							
	3000 kg	1000 g			-																							
	RHW Paslanmaz indikator Farkı ilave			....+	<b>375,00</b>																							
APS Paslanmaz indikator Farkı ilave			....+	<b>1.205,00</b>																								
<b>Özellikler :</b> U - Tipi Platform , RCW İndikator Standart Ön Çatalar Tekerlekli <b>Opsiyonlar :</b> Duvar aparatı veya seyyar boyun seçeneği																												
																												
<table border="1" style="margin-left: auto; margin-right: auto;"> <thead> <tr> <th></th> <th>A</th> <th>B</th> <th>C</th> <th>D</th> <th>h</th> </tr> </thead> <tbody> <tr> <td>120 X 80</td> <td>120</td> <td>80</td> <td>10</td> <td>60</td> <td>8,5</td> </tr> <tr> <td>120 X 84</td> <td>120</td> <td>84</td> <td>12</td> <td>60</td> <td>9</td> </tr> <tr> <td>120 X 109</td> <td>120</td> <td>109</td> <td>12</td> <td>85</td> <td>9</td> </tr> </tbody> </table> <p style="text-align: right;">* Ölçüler cm 'dir</p>						A	B	C	D	h	120 X 80	120	80	10	60	8,5	120 X 84	120	84	12	60	9	120 X 109	120	109	12	85	9
	A	B	C	D	h																							
120 X 80	120	80	10	60	8,5																							
120 X 84	120	84	12	60	9																							
120 X 109	120	109	12	85	9																							

Model	Kod	Kapasite	Taksimat	FİYAT (TL)
<b>BLOK KANTARI</b> 	<b>BK-10</b>	10 t	5 kg	<b>26.885,00</b>
	<b>BK-15</b>	15 t	5 kg	
	<b>BK-30</b>	30 t	10 kg	
	RS 232 ilavesi			
Etiket Yazıcı ilavesi LP-50				<b>\$215</b>
<b>MERMERCİLER için</b> <b>Özellikler :</b> Mermer ocaklarına özel Blok Kantarı <b>Opsiyonlar :</b> RS-232 Bağlantısı ve Yazıcı				
				







**KANCA - ÇENGEL - VİNÇ BASKÜLLER**

Model	Kod	Kapasite	Taksimat		FİYAT (TL)
<b>DGC</b> 	DGC-50	50 kg	20 g	Kancalı	125,00
	<b>ASKI BASKÜLÜ</b> Özellikler : El Askı Baskülü, LCD Gösterge, Ekran Işığı Opsiyonlar : - Güç Kaynağı : Pili				
<b>DGL</b> 	DGL-50	50 kg	20 g	Kancalı	165,00
	<b>ASKI BASKÜLÜ</b> Özellikler : El Askı Baskülü, LCD Gösterge, Opsiyonlar : Ekran Işığı Güç Kaynağı : Pili				
<b>OCS-LP</b> 	OCS-LP-300	300 kg	100 g	Kancalı	380,00
	<b>ÇENGEL BASKÜL</b>			Kasap Kancası KNC-1 (küçük boy)	280,00
	Özellikler : Sanayi Kancalı, LCD Gösterge, Ekran Işığı Opsiyonlar : Kasap Kancası Güç Kaynağı : Pili (3 adet AA pil)				
<b>OCS-SF</b> 	OCS-SF-300	300 kg	50 g	Sanayi Kancalı	725,00
	<b>ÇENGEL BASKÜL</b>			Kasap Kancası KNC-1 (küçük boy)	280,00
	Özellikler : Çengel Baskül, 360° Dönebilir kanca uçu, Uzaktan Kumandalı Kırmızı LED Gösterge, Otomatik Kapanma Opsiyonlar : Bluetooth Bağlantısı Güç Kaynağı : Akülü				
<b>OCS-GC</b> 	OCS-GC-150	150 kg	50 g	Sanayi Kancalı	610,00
	OCS-GC-300	300 kg	100 g		680,00
	<b>ÇENGEL BASKÜL</b>			Kasap Kancası KNC-1 (küçük boy)	280,00
Özellikler : Çengel Baskül, LCD Gösterge, Ekran Işığı Opsiyonlar : - Güç Kaynağı : Pili					CE

**KANCA - ÇENGEL - VİNÇ BASKÜLLER**

Model	Kod	Kapasite	Taksimat		FİYAT (TL)
<b>OCS-BE</b> 	OCS-BE-600	600 kg	100 g	Sanayi Kancalı	1.840,00
	OCS-BE-1.5t	1,5 ton	200 g		1.860,00
	OCS-BE-2t	2 ton	500 g		2.000,00
	<b>ÇENGEL BASKÜL</b> 			Kasap Kancası KNC-2 (orta boy)	310,00
				Kasap Kancası KNC-3 (büyük boy)	370,00
<b>Özellikler</b> : Sanayi Kancalı Tartım Baskülü Kırmızı LED Gösterge, Uzaktan Kumandalı, Dönebilir Kanca Uçlu <b>Opsiyonlar</b> : Kasap Kancası <b>Güç Kaynağı</b> : Akülü <span style="float: right;">CE</span>					
<b>OCS-SP</b> 	OCS-SP-600	600 kg	100 g	Sanayi Kancalı	1.680,00
	OCS-SP-1t	1 ton	200 g		1.700,00
	<b>ÇENGEL BASKÜL</b> 			Kasap Kancası KNC-2 (orta boy)	310,00
				Kasap Kancası KNC-3 (büyük boy)	370,00
	<b>Özellikler</b> : Sanayi Kancalı Tartım Baskülü, Kuvvet Ölçer (Newton) Kırmızı LED Gösterge, Uzaktan Kumandalı, Dönebilir Kanca Uçlu <b>Opsiyonlar</b> : Kasap Kancası <b>Güç Kaynağı</b> : Akülü <span style="float: right;">CE</span>				
<b>OCS-JC</b> 	OCS-JC-1t	1 ton	200 g	Sanayi Kancalı	1.270,00
	OCS-JC-2t	2 ton	500 g		1.540,00
	OCS-JC-3t	3 ton	500 g		1.810,00
	<b>VİNÇ BASKÜL</b> <b>Özellikler</b> : Sanayi Kancalı Tartım Baskülü Kırmızı LED Gösterge, Uzaktan Kumandalı, Dönebilir Kanca Uçlu <b>Opsiyonlar</b> : Kasap Kancası <b>Güç Kaynağı</b> : Pili <span style="float: right;">CE</span>				
	<b>OCS-JE</b> 	OCS-JE-3t	3 ton	500 g	Sanayi Kancalı
OCS-JE-5t		5 ton	1 kg	2.925,00	
OCS-JE-10t		10 ton	2 kg	4.300,00	
OCS-JE-15t		15 ton	5 kg	8.085,00	
<b>VİNÇ BASKÜL</b> <b>Özellikler</b> : Sanayi Kancalı Tartım Baskülü Kırmızı LED Gösterge, Uzaktan Kumandalı, Dönebilir Kanca Uçlu <b>Opsiyonlar</b> : Kasap Kancası, Kablosuz El Terminali <b>Güç Kaynağı</b> : Akülü <span style="float: right;">CE</span>					

**KANCA - ÇENGEL - VİNÇ BASKÜLLER**

Model	Kod	Kapasite	Taksimat		FİYAT (TL)
<b>OCS-SX</b> 	OCS-SX-3t	3 t	500 g	Sanayi Kancalı	3.450,00
	OCS-SX-5t	5 t	1 kg		3.980,00
	OCS-SX-10t	10 t	2 kg		5.700,00
<b>VİNÇ BASKÜL</b> <span style="float: right;">CE</span>					
<b>Özellikler</b> : Vinç Baskül, Kırmızı LED Gösterge, Uzaktan Kumandalı Dönebilir Kanca Uçlu, Ağırlık ve Kuvvet Birimleri; kg, lb, Newton <b>Opsiyonlar</b> : RS-232 Bağlantısı, Bluetooth Bağlantısı, Kablosuz Bağlantı 180, 380, 580, LP-50, BD, BP <b>Güç Kaynağı</b> : Akülü					
     					

<b>OCS-SL</b> 	OCS-SL-15 t	15 t	5 kg	Sanayi Kancalı	7.295,00
	OCS-SL-20 t	20 t	10 kg		8.200,00
<b>VİNÇ BASKÜL</b> <span style="float: right;">CE</span>					
<b>Özellikler</b> : Vinç Baskül, Kırmızı LED Gösterge, Uzaktan Kumandalı <b>Opsiyonlar</b> : Kablosuz LED Gösterge, Kablosuz El Terminali 180, 380, 580, LP-50, BD, RS-232 Bağlantısı <b>Güç Kaynağı</b> : Akülü					
     					



<b>OCS-SZL</b> 	OCS-SZL-30t	30 ton	10 kg	Sanayi Kancalı	20.960,00
	<b>VİNÇ BASKÜL</b> <span style="float: right;">CE</span>				
<b>Özellikler</b> : Vinç Baskül, Kırmızı LED Gösterge, Uzaktan Kumandalı Ağırlık ve Kuvvet Birimleri; kg, lb, Newton <b>Opsiyonlar</b> : 180, 380, 580, LP-50, BD, RS-232 Bağlantısı <b>Güç Kaynağı</b> : Akülü					
     					



**KANCA - ÇENGEL - VİNÇ BASKÜLLER**

Opsiyonlar	FİYAT (TL)
------------	------------

**OCS-SP, OCS-SX, OCS-SL, OCS-SH ve OCS-SZL modelleri için opsiyonlar :**

<b>RS-232 Bağlantısı</b> 	RS-232 bağlantısı ile haberleşme için	<b>215,00</b>
<b>Bluetooth Bağlantısı</b> 	Bluetooth bağlantısı ile bilgisayar yada yazıcı ile haberleşebilmesi için gerekli olan opsiyonel kart.	<b>430,00</b>
<b>Kablosuz Sistem Bağlantısı</b> 	Kablosuz bağlantı ile bilgisayar yada yazıcı ile haberleşebilmesi için gerekli olan opsiyonel kart.	<b>430,00</b>

**OCS-SX, OCS-SL, OCS-SH ve OCS-SZL modelleri için kablosuz bağlantılı opsiyonlar :**

<b>180</b>  	<b>Kablosuz Bilgisayar İletişim Ünitesi</b> Kablosuz iletişim ile vinç baskülüne bağlanır ve tartım bilgisini alır. Tartım bilgisini kendi LCD ekranında gösterir ve bilgisayara gönderebilir. Özel bilgisayar programında bilgiler görüntülenebilir ve listenebilir.	<b>1.600,00</b>
<b>380</b>  	<b>Kablosuz El İndikatörü</b> El Terminali 380 kablosuz iletişim ile vinç baskülüne bağlanır ve tartım bilgisini alır. Tartım bilgisini kendi LCD ekranında gösterir ve üzerindeki tuşlar ile vinç baskülünü kumanda eder.	<b>2.795,00</b>
<b>580</b>  	<b>Kablosuz Yazıcı İndikatör</b> Kablosuz iletişim ile vinç baskülüne bağlanır ve tartım bilgisini alır. Tartım bilgisini kendi LCD ekranında gösterir ve baskülü kumanda eder. Ayrıca dahili yazıcısı ile tarih, saat, tartım ve seri no bilgilerini kağıt fiş üzerine yazdırabilir.	 <b>3.625,00</b>
<b>LP-50X</b>  	<b>Kablosuz Etiket Yazıcı</b> LP-50 yazıcı ve 180P ünitesi kablosuz iletişim ile vinç baskülüne bağlanır ve tartım bilgisini alır. 180P hem baskülü kumanda eder hem de LP-50 yazıcıya komut gönderir. Böylece serbest tasarım etiket üzerine tüm bilgiler yazdırabilir.	 <b>3.645,00</b>
<b>BP</b>  	<b>Bluetooth printer</b> Akıllı telefon "Android" ileşim sistemine uygun yazılımı ile bluetooth bağlantısı üzerinden haberleşir ve kağıt fiş üzerine bilgileri yazdırır.	 <b>1.935,00</b>
<b>BD</b>  	<b>Kablosuz Extra Gösterge</b> Kablosuz Ekstra LED Gösterge, 3 inç boyutunda	<b>2.150,00</b>

**KANCA - ÇENGEL - VİNÇ BASKÜLLER**

Model	Kod	Kapasite	Taksimat	FİYAT (TL)	
<b>OCS-SD</b> 	<b>OCS-SD-300</b>	300 kg	100 g	Sanayi Kancalı	
	<b>OCS-SD-500</b>	500 kg	200 g		
	<b>OCS-SD-1000</b>	1 ton	500 g		
	<b>ONAYLI ÇENGEL BASKÜL</b>			Kasap Kancası KNC-2 (orta boy)	<b>310,00</b>
				Kasap Kancası KNC-3 (büyük boy)	<b>370,00</b>
<b>Özellikler</b> : Ticari Onaylı Çengel Tartım Baskülü, LCD Göstergeli Uzaktan Kumandalı, Dönebilir Kanca Uçlu <b>Opsiyonlar</b> : Kasap Kancası <b>Güç Kaynağı</b> : Akülü					
					
<b>ACS</b> 	<b>ACS-600</b>	600 kg	200 g	Sanayi Kancalı	
	<b>ACS-1500</b>	1500 kg	500 g		
	ABM indikatör + kablosuz bağlantı için fiyat alınız				
<b>KABLOSUZ SİSTEM DONANIMLI VİNÇ BASKÜL</b>					
<b>Özellikler</b> : Sanayi Kancalı ve Kablosuz Bağlantılı Vinç Tartım Baskülü Kırmızı LED Gösterge, Dönebilir Kanca Uçlu Kablosuz Bağlantı Sistemi ile ABM indikatör ile iletişim					
<b>Opsiyonlar</b> : Yedek ikinci akü LP-50 etiket yazıcı					
<b>Güç Kaynağı</b> : Akülü					
					
<b>OCS-SW</b> 	<b>OCS-SW2-10</b>	10 t	5 kg	El Terminali	
	<b>KABLOSUZ SİSTEM VİNÇ BASKÜLÜ</b>				
	<b>Özellikler</b> : Kablosuz Sistem, LCD Gösterge, Ekran Işığı, El terminali (280)				
	<b>Opsiyonlar</b> : RS-232 Bağlantısı <b>Güç Kaynağı</b> : Akülü				
					
<b>OCS-SW6-10</b>	10 t	5 kg	Yer Terminali (yazıcılı)	<b>9.000,00</b>	
<b>KABLOSUZ SİSTEM VİNÇ BASKÜLÜ</b>					
<b>Özellikler</b> : Kablosuz Sistem, LCD Gösterge, Ekran Işığı, Yer terminali (680)					
<b>Opsiyonlar</b> : RS-232 Bağlantısı <b>Güç Kaynağı</b> : Akülü					
					

**TRANSPALET BASKÜLLER**

Model	Kod	Kapasite	Taksimat	Çatal Arası	FİYAT (TL)
<b>NDP-RAW</b> 	NDP-550-RAW	2 t	1 kg	Çatal Arası : 55 cm	<b>5.495,00</b>
	Opsiyonel RS-232 Bağlantısı			RS-232	<b>145,00</b>
	Fiş Veren Nokta Vuruşlu Yazıcı				<b>\$110,00</b>
	Kablosuz (Wireless) Modülü			1 set (2x WM)	<b>\$150,00</b>
	<b>TRANSPALET BASKÜL</b> <b>Özellikler</b> : Transpalet Tartım Baskülü, Otomatik Kapanma LCD Gösterge, Sensörlü Otomatik Ekran Işığı <b>Opsiyonlar</b> : RS-232 Bağlantısı <b>Güç Kaynağı</b> : Akülü				



CE

<b>NDP-ABM</b> 	NDP-550-ABM	2 t	1 kg	Çatal Arası : 55 cm	<b>5.970,00</b>
	Opsiyonel RS-232 Bağlantısı			RS-232	<b>195,00</b>
	Fiş Veren Nokta Vuruşlu Yazıcı				<b>\$110,00</b>
	Etiket veya Fiş Veren Termal Yazıcı			LP-50 / EP-50	<b>\$240,00</b>
	Kablosuz (Wireless) Modülü			1 set (2x WM)	<b>\$150,00</b>

**TRANSPALET BASKÜL**

- Özellikler** : Transpalet Tartım Baskülü  
 LCD Gösterge, Ekran Işığı  
 Ağırlık Bazında Üst Üste Toplama Özelliği=  
**Opsiyonlar** : RS-232 Bağlantısı, Bluetooth Bağlantısı  
**Güç Kaynağı** : Akülü

Kağıt Fiş Örneği:

S/N	WT-Kg
1-	0.00
2-	0.00
3-	1.26
3/	2.00

Etiket Örneği:

DİKOMSAN		DT	
8212 283 32 15		www.dikomsan.com	
scale@dikomsan.com		07-06-2008 16:02	
T.NET AGR. :	7.045 kg	S.No: 05	
T.GRS. AGR. :	7.045 kg		
T.DR. AGR. :	0.000 kg		
DR. AGR. :	0.000 kg		
H. TARTIH :	0.555 kg		



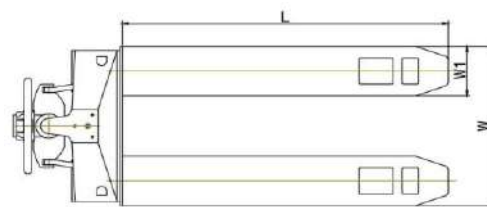
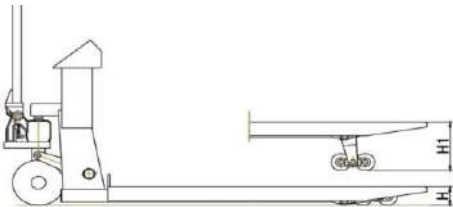

CE

**TRANSPALET ÖLÇÜLERİ :**

Model	W	W1	H	H1	L
NDP-550	550 mm	160 mm	78 mm	195 mm	1150 mm
NDP-685	685 mm	160 mm	78 mm	195 mm	1150 mm
NTP-550	550 mm	160 mm	78 mm	195 mm	1150 mm
NSP-550	550 mm	160 mm	78 mm	195 mm	1150 mm

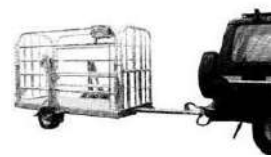

## CANLI HAYVAN BASKÜLLERİ

Model	Özellikler				FİYAT (TL)	
<b>CHB</b>     	<b>KÜÇÜK BAŞ</b> Hayvan Baskülü Tek Yük Hücreli	600 kg 100 / 200g  h=80 cm korkuluklu tek kapılı	80 x 90 cm	CE HCW indikatör	2.315,00	
		M CE RAW indikatör		2.510,00		
	<b>ORTA BAŞ</b> Hayvan Baskülü Tek Yük Hücreli	600 kg 100 / 200g  h=80 cm korkuluklu Çift kapılı	110 x 70 cm	CE HCW indikatör	2.890,00	
		M CE RAW indikatör		3.045,00		
	<b>BÜYÜK BAŞ</b> Hayvan Baskülü 4 Yük Hücreli	600kg x 200g 1500kg x 500g  h=100 cm Korkuluklu iki kapılı	100 x 200 cm	CE CW indikatör	5.000,00	
		M CE RAW indikatör		5.730,00		
		M CE RCW indikatör		5.910,00		
		600kg x 200g 1500kg x 500g  h=120 cm Korkuluklu iki kapılı çift rampalı	120 x 200 cm 120=10+100+10 200=20+160+20	M CE RCW indikatör	6.220,00	
		600kg x 200g 1500kg x 500g  h=150 cm Korkuluklu iki kapılı çift rampalı	140 x 240 cm 140=10+120+10 240=20+200+20	M CE RCW indikatör	6.900,00	
	<b>MOBİL</b> <b>BÜYÜK BAŞ</b> Hayvan Baskülü 4 Yük Hücreli	600kg x 200g 1500kg x 500g  h=120 cm Korkuluklu iki kapılı çift rampalı	120 x 200 cm 120=10+100+10 200=20+160+20	M CE RCW indikatör	9.610,00	
	<b>CANLI HAYVAN BASKÜLLERİ</b> <b>Özellikler</b> : LCD Gösterge , Işıklı, Akülü <b>Opsiyonlar</b> : RS-232 Bağlantısı, Yazıcı <b>MOBİL CANLI HAYVAN BASKÜLÜ</b> Tekerlekli, Kolay Taşınabilir					

## VETERİNER TİPİ BASKÜLLER

Model	Özellikler				FİYAT (TL)		
<b>V-HCW</b> 	<b>VETERİNER BASKÜLÜ</b>				<b>B</b>	<b>S</b>	
	<b>V-HCW</b>	200 kg	50 g	50 x 70 cm	HB	<b>1.385,00</b>	-
				57 x 78 cm	4P	<b>1.575,00</b>	-
				92 x 92 cm		<b>1.865,00</b>	-
<b>VETERİNER BASKÜLLERİ</b> <b>Özellikler :</b> LCD Gösterge Işıklı, Akülü <b>Opsiyonlar :</b> RS-232 Bağlantısı, Yazıcı, Bluetooth							



<b>V-RAW</b> 	<b>V-RAW</b>	150 kg 300 kg	50 g 100 g	57 x 78 cm	4P	<b>1.730,00</b>	-
				60 x 80 cm	US	-	<b>1.920,00</b>
				55 x 95 cm	US	-	<b>2.200,00</b>
				80 x 120 cm	US	-	<b>2.700,00</b>
	<b>V-RAW-S</b>   	<b>V-RAW</b>	600 kg	200 g	78 x 119 cm	4P	<b>2.005,00</b>
92 x 92 cm					<b>2.020,00</b>		-
<b>VETERİNER BASKÜLLERİ</b> <b>Özellikler :</b> LCD Gösterge Işıklı, Akülü <b>Opsiyonlar :</b> RS-232 Bağlantısı, Yazıcı							



## KANCALI ET BASKÜLÜ

Model	Kod	Kapasite	Taksimat	Platform	FİYAT (TL)
	K-RCW-600	600 kg	100 g 200 g	80 x 90 cm Boyalı Kule Boyalı Platform KNC-6 Paslanmaz Kancalı	5.010,00
	KS-RCW-600			80 x 90 cm Paslanmaz Kule Boyalı Platform KNC-6 Paslanmaz Kancalı	6.305,00
	KS-RCW-600S			80 x 90 cm Paslanmaz Kule Paslanmaz Üst Tabla KNC-6 Paslanmaz Kancalı	8.115,00
	K-RCW-600-4L			100 x 100 cm Boyalı Kule Boyalı Platform KNC-6 Paslanmaz Kancalı	6.750,00
	KS-RCW-600-4L			100 x 100 cm Paslanmaz Kule Paslanmaz Üst tabla KNC-6 Paslanmaz Kancalı	10.340,00
<p><b>Kancalı Et Baskülü</b></p> <p>Platform ölçüleri : 80 x 90 cm 100 x 100 cm</p> <p><b>KNC-6 : 6 Adet Paslanmaz Kancalı</b></p> <p><b>M CE</b></p>					



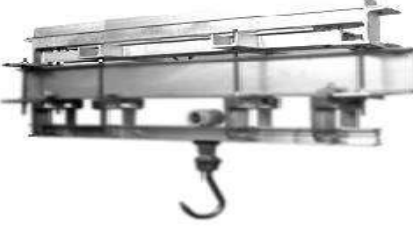

	K-RCW-600-4L	600 kg	100 g 200 g	100 x 100 cm Boyalı Kule Boyalı Platform KNC-12 Paslanmaz Kancalı	9.085,00
	KS-RCW-600-4L			100 x 100 cm Paslanmaz Kule Boyalı Platform KNC-12 Paslanmaz Kancalı	10.465,00
	KS-RCW-600-4LS			100 x 100 cm Paslanmaz Kule Paslanmaz Üst Tabla KNC-12 Paslanmaz Kancalı	12.245,00
	K-RCW-1000-4L	1000 kg	200 g 500 g	100 x 100 cm Boyalı Kule Boyalı Platform KNC-12 Paslanmaz Kancalı	9.340,00
	KS-RCW-1000-4L			100 x 100 cm Paslanmaz Kule Boyalı Platform KNC-12 Paslanmaz Kancalı	10.725,00
	KS-RCW-1000-4LS			100 x 100 cm Paslanmaz Kule Paslanmaz Üst Tabla KNC-12 Paslanmaz Kancalı	12.375,00
<p><b>Kancalı Et Baskülü</b></p> <p>Platform ölçüleri : 100 x 100 cm Direk Yüksekliği : 145 cm Yerden Yükseklik : 160 cm</p> <p><b>KNC-12 : 12 Adet Paslanmaz Kancalı</b></p> <p>* Tüm modellerde seyyar boyun elektrostatik-fırın boyalıdır * Sehpa opsiyoneldir, lütfen fiyat isteyiniz</p> <p><b>M CE</b></p>					

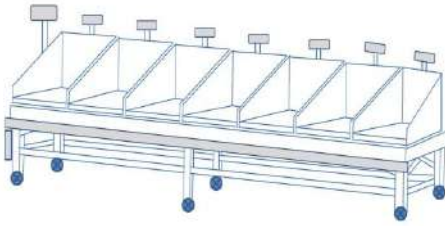
## KANCALI ET BASKÜLÜ

Model	Kod	Kapasite	Taksimat	FİYAT (TL)
<b>MONORAY BASKÜLLER</b>  	<b>MNR-600</b>	600 kg	100 g	<b>Fiyat Alınız</b>
	<b>MNR-1000</b>	1000 kg	200 g	
	<b>MONORAY SİSTEM BASKÜLLER</b>  Ürünlerin Hat Üzerinde İlerlerken Tartılması 2 adet loadcell ve bir indikatörden oluşan set olarak paket fiyat verilmektedir. İmalat, montaj ve kurulum dahil değildir.			

<b>KURBAN - HİSSE BASKÜLÜ</b>  	<b>KUR -RCW</b>	150 kg	20/50 g	<b>Fiyat Alınız</b>
	<b>KUR-RAW</b>			
		1500 kg	200/500 g	
<b>7 Bölmeli Kurban Baskülü (7+1=8 İndikatörlü)</b> Özel Poşet Asma Sistemli Paslanmaz Siperlikler Toplam Ağırlığı ve hisse payını gösteren Ana Gösterge 7 adet 150 kg kapasiteli 40 x 50 cm kefeli Tartım Baskülü ve 1 Adet 1500 kg Kapasiteli 60 x 300 cm boyutlu Tartım Ana baskül Büyük Kırmızı LED veya LCD Göstergeli Otomatik Kapanma Fonksiyonu Şarj Edilebilir Akülü Opsiyonel : Komple Paslanmaz Gövdeli modeller				
<b>CE</b>				

## MEDİKAL BASKÜLLER (DİALİZ)

Model	Kod	Kapasite	Taksimata	FİYAT (TL)		
<b>CW300 90x120 SR-4P</b> <b>SR-4P/S</b> 	<b>SR-4P</b> Elektro statik Fırın Boyalı	150 kg	50 g	<b>90 x 120 cm</b> (20+100=120)	<b>3.395,00</b>	
		300 kg	100 g		<b>3.725,00</b>	
		600 kg	200 g		<b>1.115,00</b>	
		Paslanmaz tutamak farkı				
	<b>SR-4P/S</b> PaslanmazGövde	150 kg	50 g		<b>8.460,00</b>	
		300 kg	100 g		<b>9.630,00</b>	
		600 kg	200 g			
	<b>KENDİNDEN TEK RAMPALI</b> Elektrostatik Fırın Boyalı veya Paslanmaz Modeller <div style="text-align: right;"><b>CE</b></div>					
	<b>RCW300A 90x120 SR-4A</b> <b>SR-4A/S</b> 	<b>SR-4A</b> Elektro statik Fırın Boyalı	150 kg	50 g	<b>90 x 120 cm</b> (20+100=120)	<b>4.785,00</b>
			300 kg	100 g		<b>5.025,00</b>
600 kg			200 g	<b>1.115,00</b>		
Paslanmaz tutamak farkı						
<b>SR-4A/S</b> PaslanmazGövde		150 kg	50 g		<b>9.945,00</b>	
		300 kg	100 g		<b>11.010,00</b>	
		600 kg	200 g			
<b>KENDİNDEN TEK RAMPALI</b> (OIML Onaylı) Elektrostatik Fırın Boyalı veya Paslanmaz Modeller <div style="text-align: right;"><b>M CE</b></div>						
<b>CW300N 90x120 DR-4P</b> <b>DR-4P/S</b> 		<b>DR-4P</b> Elektro statik Fırın Boyalı	150 kg	50 g	<b>90 x 120 cm</b> (20+80+20=120)	<b>3.725,00</b>
			300 kg	100 g		<b>4.135,00</b>
	600 kg		200 g	<b>1.115,00</b>		
	Paslanmaz tutamak farkı					
	<b>DR-4P/S</b> PaslanmazGövde	150 kg	50 g		<b>8.815,00</b>	
		300 kg	100 g		<b>10.140,00</b>	
		600 kg	200 g			
	<b>KENDİNDEN ÇİFT RAMPALI</b> Elektrostatik Fırın Boyalı ve Paslanmaz Modeller <div style="text-align: right;"><b>CE</b></div>					
	<b>RCW300A 90x120 DR-4A</b> <b>DR-4A/S</b> 	<b>DR-4A</b> Elektro statik Fırın Boyalı	150 kg	50 g	<b>90 x 120 cm</b> (20+80+20=120)	<b>5.210,00</b>
			300 kg	100 g		<b>5.525,00</b>
600 kg			200 g	<b>1.115,00</b>		
Paslanmaz tutamak farkı						
<b>DR-4A/S</b> PaslanmazGövde		150 kg	50 g		<b>10.400,00</b>	
		300 kg	100 g		<b>11.625,00</b>	
		600 kg	200 g			
<b>KENDİNDEN ÇİFT RAMPALI</b> (OIML onaylı) Elektrostatik Fırın Boyalı ve Paslanmaz Modeller <div style="text-align: right;"><b>M CE</b></div>						





## MEDİKAL BASKÜLLER (DİALİZ)

Model	Kod	Kapasite	Taksimat	FİYAT (TL)	
<b>HWP-ET 300N 90x120 SR-4P SR-4P/S</b> 	<b>SR-4P</b> Elektrostatik Fırın Boyalı	150 kg	50 g	<b>90 x 120 cm</b> (20+100=120)	4.135,00
		300 kg	100 g		4.470,00
		600 kg	200 g		1.115,00
		Paslanmaz tutamak farkı			
	<b>SR-4P/S</b> Paslanmaz Gövde	150 kg	50 g	<b>90 x 120 cm</b> (20+100=120)	9.250,00
		300 kg	100 g		10.420,00
		600 kg	200 g		
	<b>KENDİNDEN TEK RAMPALI</b> Elektrostatik Fırın Boyalı veya Paslanmaz Modeller  <b>HWP</b> : Fiş yazıcılı indikatör <b>SR-4P</b> : Tek Rampalı ve Elektrostatik Fırın Boyalı model <b>SRS-4P</b> : Tek Rampalı ve Paslanmaz Gövdeli model  Date: 6.04.2015 Time:10:20PM Weight Sr.No. : S00001 G.W. : 5.370 kg T.W. : 0.000 kg N.W. : 5.370 kg  <div style="text-align: right;"><b>CE</b></div>				

Model	Kod	Kapasite	Taksimat	FİYAT (TL)	
<b>HWP-ET 300N 90x120 DR-4P DR-4P/S</b> 	<b>DR-4P</b> Elektrostatik Fırın Boyalı	150 kg	50 g	<b>90 x 120 cm</b> (20+80+20=120)	4.745,00
		300 kg	100 g		5.155,00
		600 kg	200 g		1.115,00
		Paslanmaz tutamak farkı			
	<b>DR-4P/S</b> Paslanmaz Gövde	150 kg	50 g	<b>90 x 120 cm</b> (20+80+20=120)	10.400,00
		300 kg	100 g		11.790,00
		600 kg	200 g		
	<b>KENDİNDEN ÇİFT RAMPALI</b> Elektrostatik Fırın Boyalı veya Paslanmaz Modeller  <b>HWP</b> : Fiş yazıcılı indikatör <b>DR-4P</b> : Çift Rampalı ve Elektrostatik Fırın Boyalı model <b>DRS-4P</b> : Çift Rampalı ve Paslanmaz Gövdeli model  Date: 6.04.2015 Time:10:20PM Weight Sr.No. : S00001 G.W. : 5.370 kg T.W. : 0.000 kg N.W. : 5.370 kg  <div style="text-align: right;"><b>CE</b></div>				

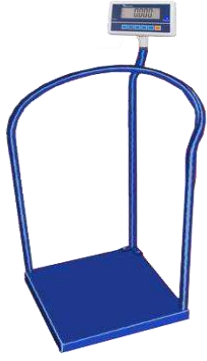
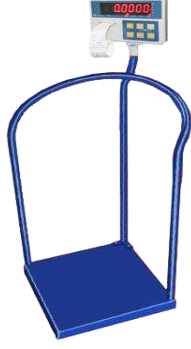
**BEBEK & İNSAN TERAZİLERİ**

Model	Kod	Kapasite				FİYAT (TL)	
<b>EBSC</b> 	EBSC-20	20 kg 5 g					
	<b>BEBEK TERAZİSİ</b> <b>Özellikler</b> : Bebek Tartım Baskülü, Dahili Boy Ölçer Metre (Mezura) LCD Gösterge, Ekran Işığı, Hafıza Fonksiyonu (Tartım değerini Kayıt), Otomatik Kapanma Özelliğı <b>Güç Kaynağı</b> : 4 Adet AA pil						CE
<b>HCW-HR</b> 	HCW-200HR	200 kg 50 g	45 x 45 cm	4P		1.635,00	
	HCW-300HR	300 kg 100 g					
<b>Tutunma Barlı İnsan Baskülü</b> <b>Özellikler</b> : Tutunma Barlı İnsan Baskülü, Kolay ve Rahat Tutunma Barı Sistemi Hassas ve Kararlı Tartım, Geniş LCD ekran, Parlak Ekran Işığı Toplama ve Sayma Fonksiyonu <b>Opsiyonlar</b> : Boy ölçer						CE	
<b>HWP-HR</b> 	HWP-200HR	200 kg 50 g	45 x 45 cm	4P		2.525,00	
	HWP-300HR	300 kg 100 g					
<b>Tutunma Barlı İnsan Baskülü - Yazıcı</b> <b>Özellikler</b> : Tutunma Barlı İnsan Baskülü, Kolay ve Rahat Tutunma Barı Sistemi Hassas ve Kararlı Tartım, Geniş LCD ekran, Parlak Ekran Işığı Kağıt Fiş Yazıcı <b>Opsiyonlar</b> : Boy ölçer						CE	
<b>HWP-M</b> 	HWP-M	200 kg 300 kg	50 g 100 g	35 x 40 cm	U	2.025,00	
						Boy Ölçerli	2.435,00
				40 x 50 cm			3.155,00
						Boy Ölçerli	3.495,00
<b>İNSAN BASKÜLÜ - YAZICILI</b> <b>Özellikler</b> : İnsan Baskülü, Kağıt Fiş Yazıcı Kırmızı LED Gösterge <b>Opsiyonlar</b> : Boy Ölçer <b>Güç Kaynağı</b> : Akülü						CE	

## BOY ÖLÇERLİ İNSAN BASKÜLLERİ

Model	Kod	Kapasite				FIYAT (TL)
<b>HCT-M</b> 	HCT-M	150 kg	50 g	35 x 40 cm	E	900,00
		200 kg			U	1.080,00
<p><b>Özellikler</b> : HCT-LE-Med LED Gösterge , Akülü,</p> <p style="text-align: right;"><b>CE</b></p>						
<b>HCW-M</b> 	HCW-M	200 kg	50 g	35 x 40 cm	U	1.135,00
						Boy Ölçerli
<p><b>İNSAN BASKÜLÜ</b></p> <p><b>Özellikler</b> : İnsan Tartım Baskülü, LCD Gösterge, Ekran Işığı  <b>Opsiyonlar</b> : Boy Ölçer  <b>Güç Kaynağı</b> : Akülü</p> <p style="text-align: right;"><b>CE</b></p>						
<b>BW-M</b> 	BW-200	200 kg	50 g	35 x 40 cm	H	1.050,00
					U	1.275,00
						Boy Ölçerli
<p><b>İNSAN BASKÜLÜ</b></p> <p><b>Özellikler</b> : İnsan Tartım Baskülü, LCD Gösterge, Ekran Işığı  <b>Opsiyonlar</b> : Boy Ölçer  <b>Güç Kaynağı</b> : Akülü</p> <p style="text-align: right;"><b>CE</b></p>						
<b>BMI</b> 	BMI-200	200 kg	50 g	35 x 40 cm	U	1.920,00
						Boy Ölçerli
	BMI-300	300 kg	100 g	40 x 50 cm		3.045,00
						Boy Ölçerli
<p><b>VÜCUT KİTLE ORANI ÖLÇER (BMI)</b></p> <p><b>Özellikler</b> : İnsan Tartım Baskülü, LCD Gösterge, Ekran Işığı  <b>Opsiyonlar</b> : Boy Ölçer  <b>Güç Kaynağı</b> : Akülü</p> <p style="text-align: right;"><b>M CE</b></p>						

## TARTIM İNDİKATÖRLERİ

Model	Özellikler		FİYAT (TL)
<b>HCW</b> 	<b>TARTIM İNDİKATÖRÜ</b> * Endüstriyel Amaçlı Tartım İndikatörü * LCD Gösterge ve Parlak Ekran Işığı * Örneklemeye İle Sayım * Akülü ve Adaptörlü * Opsiyonel RS-232 Bağlantısı	CE	390,00
<b>HCT-C</b> 	<b>TARTIM İNDİKATÖRÜ</b> * Endüstriyel Amaçlı Tartım İndikatörü * LCD Gösterge ve Parlak Ekran Işığı * Örneklemeye İle Sayım * Akülü ve Adaptörlü * Opsiyonel RS-232 Bağlantısı	CE	390,00
<b>HCT-E</b> 	<b>TARTIM İNDİKATÖRÜ</b> * Endüstriyel Amaçlı Tartım İndikatörü * Kırmızı LED Gösterge * Örneklemeye İle Sayım * Akülü ve Adaptörlü * Opsiyonel RS-232 Bağlantısı	CE	330,00
<b>DW</b> 	<b>TARTIM İNDİKATÖRÜ</b> * Endüstriyel Amaçlı Tartım İndikatörü * Kırmızı LED Gösterge * Ağırlık Bazında Üst Üste Toplama Özelliği * Örneklemeye İle Sayım * Akülü ve Adaptörlü * Opsiyonel RS-232 Bağlantısı	CE	400,00
<b>CW</b> 	<b>TARTIM İNDİKATÖRÜ</b> * Endüstriyel Amaçlı Tartım İndikatörü * LCD Gösterge ve Parlak Ekran Işığı * Ağırlık Bazında Üst Üste Toplama Özelliği * Akülü ve Adaptörlü * Opsiyonel RS-232 Bağlantısı	CE	480,00
<b>EW</b> 	<b>TARTIM İNDİKATÖRÜ</b> * Endüstriyel Amaçlı Tartım İndikatörü * LED Gösterge * Ağırlık Bazında Üst Üste Toplama Özelliği * Akülü ve Adaptörlü * Opsiyonel RS-232 Bağlantısı	CE	480,00

## TARTIM İNDİKATÖRLERİ

Model	Özellikler		FİYAT (TL)
<b>RAW</b> 	<b>TARTIM İNDİKATÖRÜ</b> <ul style="list-style-type: none"> <li>* Ticari Onaylı Tartım İndikatörü</li> <li>* LCD Gösterge ve Parlak Ekran Işığı</li> <li>* Örneklemeye ile Sayım</li> <li>* Ağırlık Bazında Üst Üste Toplama Özelliği</li> <li>* Akülü ve Adaptörlü</li> <li>* Opsiyonel RS-232 Bağlantısı</li> <li>* (Hi-LoW) Alt-Üst limitleme ile ağırlık kontrolü</li> </ul>		490,00
<b>RCW</b> 	<b>TARTIM İNDİKATÖRÜ</b> <ul style="list-style-type: none"> <li>* Ticari Onaylı Tartım İndikatörü</li> <li>* LCD Gösterge ve Parlak Ekran Işığı</li> <li>* İkili Taksimat (Dual-Range)</li> <li>* Ağırlık Bazında Üst Üste Toplama Özelliği</li> <li>* Örneklemeye ile Sayım</li> <li>* Akülü ve Adaptörlü</li> <li>* Opsiyonel RS-232 Bağlantısı</li> </ul>		735,00
<b>REW</b> 	<b>TARTIM İNDİKATÖRÜ</b> <ul style="list-style-type: none"> <li>* Ticari Onaylı Tartım İndikatörü</li> <li>* Kırmızı LED Gösterge</li> <li>* İkili Taksimat (Dual-Range)</li> <li>* Ağırlık Bazında Üst Üste Toplama Özelliği</li> <li>* Örneklemeye ile Sayım</li> <li>* Akülü ve Adaptörlü</li> <li>* Opsiyonel RS-232 Bağlantısı</li> </ul>		735,00
<b>RMW</b> 	<b>TARTIM İNDİKATÖRÜ</b> <ul style="list-style-type: none"> <li>* Ticari Onaylı Tartım İndikatörü</li> <li>* LCD Gösterge ve Parlak Ekran Işığı</li> <li>* İkili Taksimat (Dual-Range)</li> <li>* Ağırlık Bazında Üst Üste Toplama Özelliği</li> <li>* Örneklemeye ile Sayım</li> <li>* Akülü ve Adaptörlü</li> <li>* Opsiyonel RS-232 Bağlantısı</li> </ul>		790,00
<b>APM</b> 	<b>TARTIM İNDİKATÖRÜ</b> <ul style="list-style-type: none"> <li>* Ticari Onaylı Tartım İndikatörü</li> <li>* LCD Gösterge ve Parlak Ekran Işığı</li> <li>* İkili Taksimat (Dual-Range)</li> <li>* Akülü ve Adaptörlü</li> <li>* Opsiyonel RS-232 Bağlantısı</li> </ul>		775,00
<b>ABM</b> 	<b>TARTIM İNDİKATÖRÜ</b> <ul style="list-style-type: none"> <li>* Ticari Onaylı Tartım İndikatörü</li> <li>* LCD Gösterge ve Parlak Ekran Işığı</li> <li>* İkili Taksimat (Dual-Range)</li> <li>* Ağırlık Bazında Üst Üste Toplama Özelliği</li> <li>* Akülü ve Adaptörlü</li> <li>* Opsiyonel RS-232 Bağlantısı</li> <li>* Opsiyonel Bluetooth Bağlantısı</li> </ul>		1.190,00
<b>ATM</b> 	<b>TARTIM İNDİKATÖRÜ</b> <ul style="list-style-type: none"> <li>* Ticari Onaylı Tartım İndikatörü</li> <li>* LCD Gösterge ve Parlak Ekran Işığı</li> <li>* İkili Taksimat (Dual-Range)</li> <li>* Ağırlık Bazında Üst Üste Toplama Özelliği</li> <li>* Akülü ve Adaptörlü</li> <li>* Opsiyonel RS-232 Bağlantısı</li> <li>* Opsiyonel Bluetooth Bağlantısı</li> </ul>		1.125,00









## TARTIM İNDİKATÖRLERİ

Model	Özellikler		FIYAT (TL)
<b>AFM-18</b> 	<b>TARTIM İNDİKATÖRÜ</b> <ul style="list-style-type: none"> <li>* Ticari Onaylı Tartım İndikatörü</li> <li>* Endüstriyel Kullanımda Yüksek Hassasiyet</li> <li>* LCD Gösterge ve Parlak Ekran Işığı</li> <li>* İkili Taksimat (Dual-Range)</li> <li>* Çok Çeşitli Fonksiyonlar</li> <li>* Akülü ve Adaptörlü</li> <li>* Opsiyonel RS-232 Bağlantısı</li> </ul>		915,00
<b>19i</b> 	<b>TARTIM İNDİKATÖRÜ</b> <ul style="list-style-type: none"> <li>* Endüstriyel Amaçlı Tartım İndikatörü</li> <li>* Yüksek Hassasiyet Tartım</li> <li>* LCD Gösterge ve Parlak Ekran Işığı</li> <li>* İkili Taksimat (Dual-Range)</li> <li>* Çok Çeşitli Fonksiyonlar</li> <li>* Akülü ve Adaptörlü</li> <li>* Çift RS-232 Bağlantısı (birbirinden ayrı iki bağlantı)</li> </ul>		1.280,00
<b>ASB</b> 	<b>TARTIM İNDİKATÖRÜ</b> <ul style="list-style-type: none"> <li>* Ticari Onaylı Tartım İndikatörü</li> <li>* LCD Gösterge ve Parlak Ekran Işığı</li> <li>* İkili Taksimat (Dual-Range)</li> <li>* Ağırlık Bazında Üst Üste Toplama Özelliği</li> <li>* Akülü</li> <li>* Opsiyonel RS-232 Bağlantısı</li> </ul>		810,00
<b>SEW-IN -R</b> 	<b>TARTIM İNDİKATÖRÜ</b> <ul style="list-style-type: none"> <li>* Ticari Onaylı Tartım İndikatörü</li> <li>* LCD Gösterge ve Parlak Ekran Işığı</li> <li>* İkili Taksimat (Dual-Range)</li> <li>* Akülü ve Adaptörlü</li> <li>* Opsiyonel RS-232 Bağlantısı</li> <li>* Opsiyonel (Ön ve Arka) çift taraf Gösterge + 20 TL</li> </ul>		1.040,00
<b>DT</b> 	<b>TARTIM İNDİKATÖRÜ</b> <ul style="list-style-type: none"> <li>* Endüstriyel Amaçlı Tartım İndikatörü</li> <li>* LCD Gösterge ve Parlak Ekran Işığı</li> <li>* Örneklemeye İle Sayım</li> <li>* Ağırlık Bazında Üst Üste Toplama Özelliği</li> <li>* Akülü ve Adaptörlü</li> <li>* Opsiyonel RS-232 Bağlantısı</li> <li>* Opsiyonel USB Bağlantısı</li> </ul>		955,00
<b>FM-28</b> 	<b>TARTIM İNDİKATÖRÜ</b> <ul style="list-style-type: none"> <li>* Endüstriyel Amaçlı Tartım İndikatörü</li> <li>* Yüksek Hassasiyet Tartım</li> <li>* LCD Gösterge ve Parlak Ekran Işığı</li> <li>* İkili Taksimat (Dual-Range)</li> <li>* Çok Çeşitli Fonksiyonlar</li> <li>* Akülü ve Adaptörlü</li> <li>* Çift RS-232 Bağlantısı (birbirinden ayrı iki bağlantı)</li> </ul>		1.325,00
<b>NTP</b>	<b>TARTIM İNDİKATÖRÜ</b>		

## PASLANMAZ İNDİKATÖRLER







Model	Özellikler		FİYAT (TL)
<b>RHW</b> 	<b>PASLANMAZ TARTIM İNDİKATÖRÜ</b> * Ticari Onaylı Paslanmaz Tartım İndikatörü * LCD Gösterge ve Parlak Ekran Işığı * Ağırlık Bazında Üst Üste Toplama Özelliği * Akülü ve Adaptörlü * Opsiyonel RS-232 Bağlantısı		1.030,00
<b>APS</b> 	<b>PASLANMAZ TARTIM İNDİKATÖRÜ</b> * Ticari Onaylı Paslanmaz Tartım İndikatörü * LCD Gösterge ve Parlak Ekran Işığı * İkili Taksimat (Dual-Range) * Ağırlık Bazında Üst Üste Toplama Özelliği * Akülü ve Adaptörlü * Opsiyonel RS-232 Bağlantısı		1.910,00
<b>RSW</b> 	<b>PASLANMAZ TARTIM İNDİKATÖRÜ</b> * Ticari Onaylı Paslanmaz Tartım İndikatörü * LCD Gösterge ve Parlak Ekran Işığı * İkili Taksimat (Dual-Range) * Ağırlık Bazında Üst Üste Toplama Özelliği * Akülü ve Adaptörlü * Opsiyonel RS-232 Bağlantısı		1.225,00
<b>PH</b> 	<b>PASLANMAZ TARTIM İNDİKATÖRÜ</b> * Ticari Onaylı Paslanmaz Checkweigher * Çift Gösterge : Dijital ve Analog * İkili Taksimat (Dual-Range) * 10 Adet Üst ve Alt Limit Hafızalı  Opsiyonel RS-232 ve Röle Bağlantısı		1.885,00
			2.145,00
<b>19s</b> 	<b>PASLANMAZ TARTIM İNDİKATÖRÜ</b> * Ticari Onaylı Paslanmaz Tartım İndikatörü * LCD Gösterge ve Parlak Ekran Işığı * Ağırlık Bazında Üst Üste Toplama Özelliği * Akülü ve Adaptörlü * Opsiyonel RS-232 Bağlantısı		2.420,00
<b>DBS</b> 	<b>PASLANMAZ TARTIM İNDİKATÖRÜ</b> * Endüstriyel Amaçlı Paslanmaz Tartım İndikatörü * LCD Gösterge ve Parlak Ekran Işığı * Ağırlık Bazında Üst Üste Toplama Özelliği * Akülü ve Adaptörlü * Opsiyonel RS-232 Bağlantısı		605,00

## SAYICI İNDİKATÖRLER

Model	Özellikler		FİYAT (TL)
<b>DCC</b> 	<b>SAYICI İNDİKATÖR</b> * Endüstriyel Amaçlı Sayıcı İndikatör * LCD Gösterge ve Parlak Ekran Işığı * Sayım ve Tartım Fonksiyonları * Akülü ve Adaptörlü * Opsiyonel RS-232 Bağlantısı		<b>470,00</b>
<b>RCC</b> 	<b>SAYICI İNDİKATÖR</b> * Endüstriyel Amaçlı Sayıcı İndikatör * LCD Gösterge ve Parlak Ekran Işığı * Sayım ve Tartım Fonksiyonları * Akülü ve Adaptörlü * Opsiyonel RS-232 Bağlantısı * 18 adet ürün için birim ağırlık hafızası		<b>735,00</b>
<b>DC</b> 	<b>SAYICI İNDİKATÖR</b> * Endüstriyel Amaçlı Sayıcı İndikatör * LCD Gösterge ve Parlak Ekran Işığı * Sayım ve Tartım Fonksiyonları * Akülü ve Adaptörlü * Opsiyonel RS-232 Bağlantısı * 200 adet ürün için Birim Ağırlık hafızası * Alt-Üst Tartım Seviye Kontrolü * Sayım kontrol Alarmı * 3 Röle çıkış için Kontrol Kutusu bağlantısı (Opsiyon)		<b>1.020,00</b>
<b>SEC-IN</b> 	<b>SAYICI İNDİKATÖR</b> * Ticari Onaylı Sayıcı İndikatör * LCD Gösterge ve Parlak Ekran Işığı * İkili Taksimat (Dual-Range) * Akülü ve Adaptörlü * Opsiyonel RS-232 Bağlantısı * Opsiyonel Arka LCD Gösterge		<b>900,00</b>



## FİYAT HESAPLAMALI İNDİKATÖRLER

Model	Özellikler		FİYAT (TL)
<b>RCP</b> 	<b>FİYAT HESAPLAMALI İNDİKATÖR</b> * Ticari Onaylı İndikatör * LCD Gösterge ve Parlak Ekran Işığı * İkili Taksimat (Dual-Range) * 10 Adet Hafıza Tuşu * Akülü ve Adaptörlü * Opsiyonel RS-232 Bağlantısı		745,00
<b>SEP-IN-R</b> 	<b>FİYAT HESAPLAMALI İNDİKATÖR</b> * Ticari Onaylı İndikatör * LCD ön ve arka Gösterge * Parlak Ekran Işığı * İkili Taksimat (Dual-Range) * 4 Adet Direk Hafıza Tuşu * Akülü ve Adaptörlü * Opsiyonel RS-232 Bağlantısı		995,00
<b>OPP-IN</b> 	<b>FİYAT HESAPLAMALI İNDİKATÖR</b> * Ticari Onaylı İndikatör * LCD ön ve arka Gösterge * Parlak Ekran Işığı * İkili Taksimat (Dual-Range) * 40 adet Direk Hafıza Tuşu * Akülü ve Adaptörlü * Opsiyonel RS-232 Bağlantısı		1.260,00

## YAZICILI İNDİKATÖRLER

Model	Özellikler	Örnekler	FİYAT (TL)
<b>FB-530</b> 	<b>KAĞIT FİŞ YAZICILI İNDİKATÖR</b> <ul style="list-style-type: none"> <li>* Ticari Onaylı İndikatör</li> <li>* LCD Gösterge ve Parlak Ekran Işığı</li> <li>* İkili Taksimat (Dual-Range)</li> <li>* 10 Adet Hafıza Tuşu</li> <li>* Akülü ve Adaptörlü</li> <li>* Opsiyonel RS-232 Bağlantısı</li> <li>* Opsiyonel Arka Gösterge</li> </ul>		1.725,00
			1.885,00
<b>A3</b> 	<b>KAĞIT FİŞ YAZICILI İNDİKATÖR</b> <ul style="list-style-type: none"> <li>* Endüstriyel İndikatör</li> <li>* Kağıt Fiş Yazıcı</li> <li>* Kırmızı LED Gösterge</li> <li>* Hafızalı</li> <li>* Günlük rapor ve Toplam rapor</li> </ul>		1.435,00
	CE		
<b>W22</b> 	<b>KAĞIT FİŞ YAZICILI İNDİKATÖR</b> <ul style="list-style-type: none"> <li>* Endüstriyel İndikatör</li> <li>* Kağıt Fiş Yazıcı</li> <li>* LCD Gösterge</li> </ul>		1.795,00
	CE		
<b>LP-2550</b> 	<b>ETİKET YAZICILI İNDİKATÖR</b> <ul style="list-style-type: none"> <li>* Ticari Onaylı İndikatör</li> <li>* Paslanmaz Gövde</li> <li>* Fiyat Hesaplama Özellikli</li> <li>* Alfaniyemik LCD Ekran</li> <li>* 1000 Adet PLU Hafızası</li> <li>* Maksimum Etiket Boyutu 150 x 60 mm</li> <li>* Bilgisayar Programı ile Ürün Düzenleme</li> </ul>		9.630,00

## YAZICILI İNDİKATÖRLER

Model	Özellikler	Örnekler	FİYAT (TL)
<b>HWP-ET</b> 	<b>KAĞIT FİŞ YAZICILI İNDİKATÖR</b> <ul style="list-style-type: none"> <li>* Endüstriyel Tartım İndikatörü</li> <li>* Büyük Kırmızı LED Gösterge</li> <li>* Kağıt Fiş Yazıcıli Tartım İndikatörü</li> <li>* Örnekleme ile Parça Sayma</li> <li>* Alt-Üst Limitleme Fonksiyonu</li> <li>* Tartım Sonuçlarını Kümülatif Toplama</li> </ul>		<b>1.535,00</b>
<b>HWP-CL</b> 	<b>ETİKET YAZICILI İNDİKATÖR</b> <ul style="list-style-type: none"> <li>* Endüstriyel Tartım İndikatörü</li> <li>* Büyük LCD Gösterge</li> <li>* Etiket Yazıcıli Tartım İndikatörü</li> <li>* Örnekleme ile Parça Sayma</li> <li>* Alt-Üst Limitleme Fonksiyonu</li> <li>* Tartım Sonuçlarını Kümülatif Toplama</li> </ul>		<b>2.000,00</b>
<b>HCP-CL</b> 	<b>ETİKET YAZICILI İNDİKATÖR</b> <ul style="list-style-type: none"> <li>* Endüstriyel Sayıcı İndikatör</li> <li>* Büyük LCD Gösterge</li> <li>* Etiket Yazıcıli Tartım İndikatörü</li> <li>* Örnekleme ile Parça Sayma</li> <li>* Alt-Üst Limitleme Fonksiyonu</li> <li>* Tartım Sonuçlarını Kümülatif Toplama</li> </ul>		<b>2.295,00</b>
<b>HWP-D</b> 	<b>DOKUNMATİK YAZICILI İNDİKATÖR</b> <ul style="list-style-type: none"> <li>* Etiket Yazıcıli Tartım İndikatörü</li> <li>* Dokunmatik Ekran 8 inç TFT</li> <li>* Örnekleme ile Parça Sayma</li> <li>* Alt-Üst Limitleme Fonksiyonu</li> <li>* Tartım Sonuçlarını Kümülatif Toplama</li> </ul>		<b>2.295,00</b>

## YAZICILI İNDİKATÖRLER

Özellikler	Model	FİYAT (TL)
------------	-------	------------

### SPW



	<b>SPW</b>	<b>5.710,00</b>
	<b>SPC</b>	<b>5.830,00</b>
	<b>SPP</b>	<b>8.690,00</b>
	<b>İkinci Yazıcı (3 inç)</b>	<b>\$200,00</b>
	<b>İkinci Yazıcı (4 inç)</b>	<b>\$450,00</b>
	<b>LED gösterge (CX)</b>	<b>260,00</b>
	<b>3 ışıklı kolon</b>	<b>180,00</b>

### ÖZELLİKLER :

- \* LCD grafik ekranda bilgileri detaylı görme
- \* Toplam 1000 adet ürün hafızası ( 1000 PLU )
- \* Direkt hafıza ile 35 adet kısa yol erişim tuşu
- \* 100 adet farklı (serbest tasarım) etiket formatı
- \* Etiketler istenildiği gibi dizayn edilebilir
- \* Etiket tasarımına birçok logo ve resim eklenebilir
- \* Dahili termal yazıcı (2 inç)
- \* Harici termal yazıcı (3 veya 4 inç) bağlanabilir
- \* Tercihe göre etiket yerine termal fiş (sürekli kağıt) yazdırılabilir
- \* Alt-Üst Limitleme (Hi-Lo) Fonksiyonu
- \* Toplama fonksiyonu ve Toplam Etiket Yazdırma
- \* Rapor Alma Fonksiyonu
  - Günlük Rapor
  - PLU bazında toplam raporu
- \* Tüm barkod çeşitleri bulunmaktadır;  
EAN-13, UPC, Code 39, Code 128, ISBN, ...
- \* Bilgisayar bağlantısı ile çift yönlü iletişim
- \* Özel bilgisayar programı ile bilgiler düzenlenebilir

### TEKNİK ÖZELLİKLER :

- \* Çözünürlük 1/100.000 ' e kadar
- \* Termal Etiket veya Sürekli Kağıt (Fiş)
- \* Maksimum Etiket Ölçüleri 55 x 94 mm
- \* Yazdırma Çözünürlüğü 230 dpi (8dot/mm)
- \* Çalışma Sıcaklığı 0°C ~ 40°C
- \* Nem Oranı %85 R.H.
- \* Güç Kaynağı : Adaptör

### OPSİYONLAR :

- \* 3 Farklı Renkte Işıklı Kolon
- \* Harici Termal Yazıcı (3 inç)
- \* Flash Bellek (USB)

Dahili Yazıcı 2 inç



opsiyonel  
Harici Yazıcı 3 veya 4 inç



Net Weight	Tare Weight	Unit	Unit Weight	Qty	Time	Date	Operator	Item No.	Item Name
1,26	0 kg				09:32:41	2015-03-13	ADMIN		ARMUT
1,66	0 kg				09:34:26	2015-03-13	ADMIN		ARMUT
1,2	0 kg				09:45:37	2015-03-13	ADMIN		ELMA
1,2	kg				09:42:40	2015-03-13	ADMIN		ELMA
1,22	0 kg				09:53:15	2015-03-13	ADMIN		BÖĞÜRLEN
3,02	0 kg				09:54:32	2015-03-13	ADMIN		MUZ
3,02	kg				09:51:38	2015-03-13	ADMIN		MUZ
3,14	0 kg				09:54:46	2015-03-13	ADMIN		MUZ
1,3	0 kg				09:55:05	2015-03-13	ADMIN		ELMA

Weight	Stable	Zero	Com	Unit Weight	Qty
3.08					

### SPW

TARTIM İNDİKATÖRÜ



### SPC

SAYICI İNDİKATÖR



### SPP

DOKUNMATİK EKLAN



## YAZICILI İNDİKATÖRLER

Özellikler	Model	FİYAT (TL)
------------	-------	------------











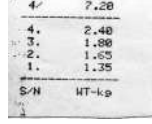



### SPW İÇİN ETİKET ÖRNEKLERİ







### SPW İÇİN BASKÜL ÖRNEKLERİ









## YAZICILAR



Model	Özellikler	Örnekler	FİYAT ( \$ )
<b>NOKTA VURUŞLU YAZICILAR</b>			
<b>M-150</b> 	Nokta Vuruşlu Yazıcı	 	<b>\$110</b>
<b>UPT</b> 	Nokta Vuruşlu Yazıcı		<b>\$100</b>
<b>TERMAL KAĞIT YAZICILAR</b>			
<b>POS-58</b> 	Termal Fiş Yazıcı	 	<b>\$130</b>
<b>EP-50</b> 	Termal Fiş Yazıcı	 	<b>\$200</b>
<b>POS-88</b> 	Termal Fiş Yazıcı		<b>\$360</b>
<b>580</b> 	Termal Fiş Yazıcı	 	<b>\$525</b>

## YAZICILAR

Model	Özellikler	Örnekler	FİYAT ( \$ )
<b>TERMAL ETİKET YAZICILAR</b>			
<b>LP-50</b> 	<b>Barkodlu Termal Etiket veren Yazıcı</b>		\$200
<b>GP-3120TN</b> 	<b>Barkodlu Termal Etiket veren Yazıcı</b>		\$200
<b>DT-4x</b> 	<b>Barkodlu Termal Etiket veren Yazıcı</b>		\$360







<b>ÇOK FONKSİYONLU YAZICILAR</b>			
<b>LP-1</b> 	<b>Barkodlu Termal Etiket / Fiş Yazıcı</b> <ul style="list-style-type: none"> <li>* Termal Etiket veya Fiş yazabilir</li> <li>* LCD Ekran</li> <li>* 1024 Adet PLU Ürün Hafızası</li> <li>* 40 Adet Direk Hafıza Tuşu</li> <li>* Bilgisayar Klavyesi Bağlanabilir</li> <li>* Bilgisayar Programı ile Düzenleme</li> <li>* Maksimum Etiket Geniliği 56 mm</li> </ul>	 	\$345
<b>IP-500</b> 	<b>Barkodlu Termal Etiket / Fiş Yazıcı</b> <ul style="list-style-type: none"> <li>* Termal Etiket veya Fiş yazabilir</li> <li>* Beyaz LCD Grafik Ekran</li> <li>* 2000 Adet PLU Ürün Hafızası</li> <li>* 50 Adet Direk Hafıza Tuşu</li> <li>* 10 Farklı Etiket Formatı</li> <li>* Yazıcı ekran ve tuşlarından hafızadaki ürünleri düzenleme</li> <li>* Bilgisayar Programı ile Düzenleme</li> <li>* Maksimum Etiket 75 x 200 mm</li> <li>* Tartım, sayıcı veya fiyat hesaplama özellikli terazi veya basküllere bağlanabilir</li> <li>* RS-232 Bağlantısı</li> </ul>	 	\$560

## TARTIM KONTROL İNDİKATÖRLERİ

Model	Özellikler	FİYAT (TL)
<b>AX</b> 	<b>AX-A1</b> 4 ~ 20 mA Analog Çıkış, RS-232 bağlantısı	
	<b>AX-A2</b> 4 ~ 20 mA Analog Çıkış, RS-485 bağlantısı	
	<b>AX-B1</b> 4 ~ 20 mA Analog Çıkış ve 6 Adet Röle Çıkışı	
	<b>AX-B2</b> 4 ~ 20 mA Analog Çıkış ve 6 Adet Röle Çıkışı	
	Adaptör ilavesi	
<b>EX-2002</b> 	<p style="text-align: center;"><b>Endüstriyel İndikatör</b></p> <p style="text-align: center;">Dolum ve Paketleme Sistemleri</p> <p style="text-align: center;">Kopma ve Sıkıştırma Deneplerinde Göstergede tartım değerinin DONDURULMASI</p> <p style="text-align: center;">220 V AC Güç Kaynağı <span style="float: right;">CE</span></p>	
<b>EX-2005</b> 	<p style="text-align: center;"><b>Endüstriyel İndikatör</b></p> <p style="text-align: center;">Dolum ve Paketleme Sistemleri</p> <p style="text-align: center;">Kopma ve Sıkıştırma Deneplerinde Göstergede tartım değerinin DONDURULMASI</p> <p style="text-align: center;">12-24 V DC Güç Kaynağı <span style="float: right;">CE</span></p>	
<b>EX-2002 &amp; EX-2005 Opsiyon kartları</b>	<b>OP-01</b> RS-422 / RS-485 Seri Arayüz Kartı	
	<b>OP-02</b> Paralel Çıkış (TTL, Open Collector)	
	<b>OP-03</b> Analog Çıkış (4 ~ 20 mA / 0 ~ 10V)	
	<b>OP-04</b> 4 Röle giriş ve çıkış	
	<b>OP-05</b> 8 röle giriş ve çıkış	
<b>Transmitter</b> 	<p style="text-align: center;"><b>Endüstriyel Transmitter</b></p> <p style="text-align: center;">Loadcell ve Bilgisayar Arası</p> <p style="text-align: center;">4 ~ 20 mA 1 - 5 V Analog Çıkış <span style="float: right;">CE</span></p> <p style="text-align: center;"><b>Adaptör İlavesi</b></p>	



## İLAVE GÖSTERGELER

Model	Özellikler	FİYAT (TL)
<b>FR-1</b> 	<b>İlave LED Gösterge</b> RS-232 Bağlantısı ile 15 metre RS-485 Bağlantısı ile 1.2 kilometre Bağlandığı İndikatörler : ASB	<b>410,00</b>
<b>FR-2</b> 	<b>İlave LED Gösterge</b> RS-232 Bağlantısı ile 15 metre RS-485 Bağlantısı ile 1.2 kilometre yazıcı bağlanabilir Bağlandığı İndikatörler : ASB	<b>410,00</b>
<b>HXE</b> 	<b>İlave LED Gösterge : HXE</b>	HXE <b>260,00</b>
<b>HXC</b> 	<b>İlave LCD Gösterge : HXC</b>	HXC <b>280,00</b>
<b>LD</b> 	<b>İlave LED Gösterge</b> Bağlandığı Modeller : APM, ABM, ASB, RAW, RCW, REW, DBN, DCI, DCC, I2P-500	LD - 1,8 <b>560,00</b>
		LD - 3 <b>645,00</b>
		LD - 5 <b>780,00</b>
<b>CX</b> 	<b>İlave LED Gösterge</b> Bağlandığı Modeller : RAW, DT, JS-B, CAX, CGB	CX - 3 <b>625,00</b>
		CX - 5 <b>780,00</b>
<b>RD-DOT</b> 	<b>Multi - Fonksiyonel Gösterge</b> Kayan yazı mesajı (tek veya çift satır) uzaktan kumandalı Opsiyonel Kablosuz Bağlantı Tarih ve saat fonksiyonu Bağlandığı Modeller : FM-18, FM-28, DJB	<b>1.925,00</b>

## ZEMİC LOAD CELL ( YÜK HÜCRESİ )

Model	Özellikler	Eşdeğeri	OIML	Kapasite	FİYAT (USD)			
<b>Tek Nokta (Single Point) Yük Hücreleri</b>								
<b>L6B</b> 	Aluminium IP-65	Tedea 1004 Nmb BCL	-	-	300 g, 600 g 1 kg, 2 kg, 3 kg	<b>\$27,00</b>		
<b>L6D</b> 	Aluminium IP-65	Tedea 1022 Keli AMI Hbm PW6	OIML	C3	3, 5, 6, 8, 10, 15 kg	<b>\$17,00</b>		
				C4	20, 30, 35, 50 kg	<b>\$41,00</b>		
				C5		<b>\$65,00</b>		
<b>L6D-FS</b> 	Aluminium IP-66 <b>SU GEÇİRMEZ</b>		-	-	3, 5, 8, 10, 15 kg 20, 35, 40, 50 kg	<b>\$25,00</b>		
<b>L6D8</b> 	Aluminium IP-65	Tedea 1022	OIML	C3	100kg, 150kg, 200kg	<b>\$20,00</b>		
<b>L6N</b> 	Aluminium IP-65	Cas BCA	OIML	C3	10, 20, 30, 50, 75, 100 kg	<b>\$25,00</b>		
<b>L6E</b> 	Aluminium IP-65	Tedea 1042 Keli UDB Hbm PW15 Cas BCL	-	-	20, 30 kg	<b>\$25,00</b>		
					OIML	C3	60, 80, 100, 150, 200, 300 kg	<b>\$22,50</b>
						C4		<b>\$45,00</b>
<b>L6E3</b> 	Aluminium IP-65	Tedea 1040 Keli UDN	OIML	C3	50, 100, 150, 200, 300, 500 kg	<b>\$25,00</b>		
<b>L6Q</b> 	Aluminium IP-65	Tedea 1242 Hbm PW10	OIML	C3	50, 100, 200 kg	<b>\$40,00</b>		
<b>L6G</b> 	Aluminium IP-65	Tedea 1263 Keli UDA Cas BCD	OIML	C3	50, 100, 150, 200 kg	<b>\$50,00</b>		
				C4	250, 300, 500, 600 kg	<b>\$105,00</b>		
<b>L6W</b> 	Aluminium IP-65	Tedea 1260 Keli UDJ Hbm PW16	OIML	C3	150, 300, 500, 635 kg	<b>\$69,00</b>		
<b>L6T</b> 	Aluminium IP-65		OIML	C3	500, 635, 1000 kg	<b>\$100,00</b>		
<b>L6F</b> 	Aluminium IP-65	Tedea 1320 Keli XSB Cas BCH	OIML	C3	750 kg	<b>\$85,00</b>		
					1000 kg, 2000 kg	<b>\$138,00</b>		

## ZEMIC LOAD CELL ( YÜK HÜCRESİ )

Model	Özellikler	Eşdeğeri	Kapasite	FİYAT (USD)
<b>Tek Nokta (Single Point) Yük Hücreleri</b>				
<b>B6E</b> 	Paslanmaz Çelik		75, 100, 150 kg 200 , 300 kg	<b>\$125,00</b>
<b>BM6E</b> 	Paslanmaz Çelik IP-68		50, 75, 100, 200 kg	<b>\$145,00</b>
<b>B6E3</b> 	Paslanmaz Çelik IP-66		60, 150 kg	<b>\$150,00</b>
<b>B6N</b> 	Paslanmaz Çelik		50, 100, 200 kg	<b>\$125,00</b>
<b>B6Q</b> 	Paslanmaz Çelik		150 , 200 kg	<b>\$143,00</b>
<b>B6F</b> 	Paslanmaz Çelik		750 kg, 1 t	<b>\$245,00</b>
			2 t	<b>\$667,00</b>
<b>BM6G</b> 	Paslanmaz Çelik IP-69 OIML / C3		100 kg	<b>\$156,00</b>
			200, 300, 500 kg	<b>\$234,00</b>
<b>Lama Tipi (Shear Beam) Yük Hücreleri</b>				
<b>H8C</b> 	Çelik Alaşım IP-65 OIML / C3	Tedeia 3410 Keli SQB Cas BS-BSA	100 ,150 ,250 ,500 kg ,1 ,2 t	<b>\$49,00</b>
			3 t , 5 t	<b>\$60,00</b>
			10 t	<b>\$114,00</b>
<b>HM8C</b> 	Çelik Alaşım IP-65 OIML / C3		1 t , 2 t	<b>\$78,00</b>
			3 t , 5 t	<b>\$94,00</b>
<b>H8</b> 	Çelik Alaşım IP-65 OIML / C3		5 t, 10 t, 20 t	<b>\$167,00</b>
<b>HM8</b> 	Çelik Alaşım IP-65 OIML / C3		10 t , 20 t	<b>\$171,00</b>







## ZEMIC LOAD CELL ( YÜK HÜCRESİ )





Model	Özellikler	Eşdeğeri	Kapasite	FİYAT (USD)
<b>Lama Tipi (Shear Beam) Yük Hücreleri</b>				
<b>B8D</b> 	Paslanmaz Çelik		200, 500 kg	<b>\$129,00</b>
	IP-67		1 ton, 2 ton	
	OIML / C3		3 ton, 5 ton	<b>\$167,00</b>
<b>B8Q</b> 	Paslanmaz Çelik		500 kg	<b>\$120,00</b>
	IP-67		1 ton, 2 ton	
	OIML / C3			
<b>BM8D</b> 	Paslanmaz Çelik		150, 300 kg, 1 ton, 2 ton	<b>\$134,00</b>
	IP-68		3 ton, 5 ton	<b>\$156,00</b>
	OIML / C3		10 ton	<b>\$230,00</b>
<b>BM8G</b> 	Paslanmaz Çelik		1 ton	<b>\$156,00</b>
	IP-68		3 ton, 5 ton	<b>\$234,00</b>
	OIML / C3		3 ton, 5 ton	<b>\$400,00</b>
<b>BM8H</b> 	Paslanmaz Çelik		250, 500 kg, 1 t, 2 t	<b>\$112,00</b>
	IP-68			
	OIML / C3		3 ton, 5 ton	<b>\$134,00</b>
<b>S Tipi (S-Type) Yük Hücreleri</b>				
<b>H3</b> 	Aliminium		25, 50, 100, 150, 200, 500 kg	<b>\$64,00</b>
			600,750,1000,1500 kg	<b>\$65,00</b>
	IP-65		3 t, 5 t	<b>\$86,00</b>
	C3		7.5 t, 10 t	<b>\$145,00</b>
			20 t	<b>\$190,00</b>
<b>H3G</b> 	Aliminium		500 kg, 1 t	<b>\$100,00</b>
			5 t	<b>\$125,00</b>
	C3		7.5 t	<b>\$192,00</b>
			10 t	
<b>B3G</b> 	Paslanmaz Çelik		500 kg, 1 t	<b>\$139,00</b>
	IP-68		5 t	<b>\$194,00</b>
	C3		7.5 t	<b>\$252,00</b>
			10 t	<b>\$383,00</b>

## ZEMIC LOAD CELL ( YÜK HÜCRESİ )

Model	Özellikler	Eşdeğeri	OIML	Kapasite	FIYAT (USD)
<b>Körüklü (Bending) Yük Hücreleri</b>					
<b>BM11</b> 	Paslanmaz Çelik			20, 30, 50, 100, 200kg	<b>\$126,00</b>
	IP-68 C3			350, 500 kg	
<b>Kompresyon (Compression) Yük Hücreleri</b>					
<b>HM14C</b> 	Çelik Alaşım			10 t	
	IP-68 C3				
<b>BM14C</b> 	Paslanmaz Çelik			10 t	
	IP-68 C3				
<b>BM14G</b> 	Paslanmaz Çelik		C3	15 t , 30 t	<b>\$258,00</b>
	IP-68			50 t	<b>\$289,00</b>
<b>İkili Lama Tipi (DualShear Beam) Yük Hücreleri</b>					
<b>HM9B</b> 	Çelik Alaşım			20 t	<b>\$173,00</b>
	IP-68 C3			30 t	
<b>BM24R</b> 	Çelik Alaşım			60 , 280 kg , 1 t , 2 t	<b>\$487,00</b>
	IP-67 C2				
<b>H2F</b> 	Çelik Alaşım			3 t, 5 t	<b>\$167,00</b>
	IP-67 C2				

## KELI LOAD CELL ( YÜK HÜCRESİ )

Model	Özellikler	Eşdeğeri	Kapasite	FIYAT (USD)
<b>Tek Nokta (Single Point) Yük Hücreleri</b>				
<b>AMI</b> 	Aliminyum	Tedeia 1022 Zemic L6D HBM PW6 Cas BCL	8, 10, 15, 20, 30, 35 kg	<b>\$12,00</b>
	IP-65		100 kg	<b>\$16,00</b>
<b>UDB</b> 	Aliminyum	Zemic L6E Cas BCL	30, 35, 50, 100 kg	<b>\$17,00</b>
	IP-65		150, 200, 300 kg	
<b>UDN</b> 	Aliminyum	Tedeia 1042 Zemic L6E3 HBM PW10	150, 200, 300, 500 kg	<b>\$21,00</b>
	IP-65			
<b>UDA</b> 	Aliminyum	Tedeia 1263 Zemic L6G Cas BCD	150, 200, 300 kg	<b>\$33,00</b>
	IP-65		500, 750 kg	
<b>UDJ</b> 	Aliminyum	Tedeia Zemic L6W	750, 800 kg	<b>\$38,00</b>
<b>XSB</b> 	Aliminyum	Tedeia 1320 Zemic L6F Cas BCH Celtron HOC	750 kg	<b>\$59,00</b>
	IP-65		1000, 2000 kg	<b>\$89,00</b>
<b>ILEC-SS</b>	Paslanmaz Çelik		250, 500,750 kg	<b>\$186,00</b>
	IP-68			

Lama Tipi (Shear Beam) Yük Hücreleri				Ayaksız	Ayaklı
<b>SQB</b> 	Çelik Alaşım IP-65	Teda 3410 Zemic H8C	150, 250, 300, 500 kg 1, 1.5, 2 t	<b>\$33,00</b>	<b>\$37,00</b>
			3, 5 ton	<b>\$57,00</b>	<b>\$65,00</b>
			10 ton	<b>\$95,00</b>	<b>\$105,00</b>
<b>SQB-SS</b> 	Paslanmaz Çelik IP-68		500 kg ,1 t , 1,5 t ,2 t	<b>\$92,00</b>	<b>\$107,00</b>
			3 t , 5 t	<b>\$114,00</b>	<b>\$134,00</b>
<b>CB</b> 	Aliminyum IP-65		100, 200 kg	<b>\$57,00</b>	
<b>CB-SS</b> 	Paslanmaz Çelik IP-65		100, 200, 300 kg	<b>\$99,00</b>	

## KELI LOAD CELL ( YÜK HÜCRESİ )

Model	Özellikler	Eşdeğeri	Kapasite	FİYAT (USD)
<b>S Tipi (S-Type) Yük Hücreleri</b>				
<b>DEE</b> 	Alüminyum	Zemic H3	150kg, 300kg	<b>\$53,00</b>
	IP-65 C3		500kg	
<b>DEF</b> 	Alüminyum	Zemic H3	1 ton	<b>\$62,00</b>
	IP-65		3 ton, 5 ton	<b>\$79,00</b>
<b>HSX</b> 	Paslanmaz Çelik		100 kg ,200 kg	<b>\$105,00</b>
<b>NHS-A</b> 	Alüminyum IP-66 SU GEÇİRMEZ		4,7 ton	<b>\$97,00</b>
<b>NHS-A-ss</b> 	Alüminyum IP-65		1 ton	<b>\$114,00</b>
<b>ZSFY-A</b> 	Çelik Alaşım		30 ton	<b>\$147,00</b>
	IP-65		50 ton	<b>\$132,00</b>
<b>ZSFY-Ass</b> 	Paslanmaz Çelik		30 ton	<b>\$186,00</b>
	IP-68		50 ton	<b>\$224,00</b>
<b>LFSC-A</b> 			1t , 2t	<b>\$197,00</b>
			3 t , 5 t	<b>\$208,00</b>
			10 t , 20 t	<b>\$286,00</b>
			50 t , 60 t	<b>\$518,00</b>
<b>LFSC-E</b> 			10 t , 30 t	<b>\$250,00</b>
			50 t , 60 t	<b>\$294,00</b>
			100 t	<b>\$894,00</b>

## TEDEA LOAD CELL ( YÜK HÜCRESİ )

Model	Özellikler	Eşdeğeri	Kapasite	FİYAT (USD)
<b>Tek Nokta (Single Point) Yük Hücreleri</b>				
<b>1004</b> 	Aluminium IP-66	Zemic L6B	300g, 600g	<b>\$60,00</b>
			1200g, 1500g	
<b>1022</b> 	Aluminium	Zemic L6D Keli AMI HBM PW6	3, 5, 8, 10, 15 kg	<b>\$40,00</b>
	IP-66		20, 30, 35, 50 kg	
			100, 150 kg	<b>\$60,00</b>
<b>1042</b> 	Aluminium	Zemic L6E Keli UDB HBM PW15 Cas BCL	10, 20, 30, 50 kg	<b>\$40,00</b>
	IP-66		75, 100 kg	
<b>1130</b> 	Paslanmaz Çelik IP-66		50, 75 kg	<b>\$160,00</b>
<b>1242</b> 	Aluminium	Zemic L6Q HBM PW10	100 kg, 150 kg 200 kg	<b>\$80,00</b>
	IP-66			
<b>1260</b> 	Aluminium IP-66	Zemic L6W Keli UDJ HBM PW16	500, 635 kg	<b>\$110,00</b>
<b>1263</b> 	Aluminium	Zemic L6G Keli UDA Cas BCD	100, 150, 200 kg	<b>\$90,00</b>
	IP-66		300, 500, 635 kg	
<b>1320</b> 	Aluminium	Zemic L6F Keli XSB Cas BCH	1000 kg	<b>\$270,00</b>
	IP-67		2000 kg	
<b>Lama Tipi (Shear Beam) Yük Hücreleri</b>				
<b>3410</b> 	Çelik Alaşım	Zemic H8C Keli SQB Cas BS-BSA	250, 500, 1000 kg	<b>\$90,00</b>
	IP-67		1500, 2000 kg	





## SENSOCAR LOAD CELL ( YÜK HÜCRESİ )

Model	Özellikler	Eşdeğeri	Kapasite	FİYAT (Euro)
<b>Tek Nokta (Single Point) Yük Hücreleri</b>				
<b>PL- 50 I</b> 	Paslanmaz Çelik IP-67 C3 / C4 / C5 / C6		50, 75, 100, 200, 250 kg	<b>€ 125,00</b>
<b>BS-1 I</b> 	Paslanmaz Çelik IP-67 C3 / C4		50, 75, 100, 200, 500 kg 750, 1000 kg	<b>€ 160,00</b>
<b>BS-2 I</b> 	Paslanmaz Çelik IP-67 C3 / C4		50, 75, 100, 200, 500 kg	<b>€ 240,00</b>
<b>Lama Tipi (Shear Beam) Yük Hücreleri</b>				
<b>TA-0</b> 	Çelik Alaşım IP-67 C3 / C4 / C5 / C6		100, 150, 200, 300, 500 kg	<b>€ 115,00</b>
<b>TA-0 I</b> 	Paslanmaz Çelik IP-68 C3 / C4 / C5 / C6		100, 150, 200, 300, 500 kg	<b>€ 125,00</b>
<b>TA-1</b> 	Çelik Alaşım IP-67 C3 / C4		500, 750, 1000, 1500 kg	<b>€ 115,00</b>
<b>TA-1 I</b> 	Paslanmaz Çelik IP-68 C3 / C4		500, 750, 1000, 1500 kg	<b>€ 125,00</b>
<b>S Tipi (S-Type) Yük Hücreleri</b>				
<b>S1</b> 	Çelik Alaşım IP-67 C3 / C4 / C5 / C6		30, 50, 75, 100, 150 kg	<b>€ 120,00</b>
<b>S2-A</b> 	Çelik Alaşım IP-67 C3 / C4		300, 500, 750, 1000 kg	<b>€ 115,00</b>
<b>S2-B</b> 	Çelik Alaşım IP-67 C3 / C4		1000, 1500, 2000, 3000 kg 5000, 6000 kg	<b>€ 145,00</b>
<b>Körüklü (Bending) Yük Hücreleri</b>				
<b>FX-1</b> 	Çelik Alaşım IP-67 C3 / C4		10, 15, 25, 50, 100, 200 kg	<b>€ 140,00</b>
<b>FX-2</b> 	Çelik Alaşım IP-67 C3 / C4		50, 100, 200, 500, 750 kg 1000, 1500 kg	<b>€ 140,00</b>

## YÜK HÜCRESİ AKSESUARLARI

Model	Özellikler	Loadceller	Kapasite	FİYAT (\$)	
<b>HJ-8-201</b> 	Çelik Alaşım Ayarlanabilir Ayak		0,5 - 2 t	\$	7,50
			2,5 - 5 t	\$	12,00
			6 t - 10 t	\$	18,00
<b>HJ-8-208</b> 	Çelik Alaşım Ayarlanabilir Ayak		0,5 - 2 t	\$	7,50
			2,5 - 5 t	\$	12,00
<b>HJ-8-214</b> 	Çelik Alaşım Ayarlanabilir Ayak		0,5 - 2 t	\$	7,50
<b>BJ-8-202</b> 	Paslanmaz Çelik Ayarlanabilir Ayak		0,5 - 2 t	\$	15,00
			2,5 - 5 t	\$	
<b>BJ-8-205</b> 	Paslanmaz Çelik Ayarlanabilir Ayak		0,5 - 2 t	\$	
<b>BJ-8-206</b> 	Paslanmaz Çelik	BM8H	0,5 - 2 t	\$	20,00
			2,5 - 5 t	\$	
<b>BY-8-206</b> 	Paslanmaz Çelik			\$	
				\$	
<b>BJ-8-207</b> 	Paslanmaz Çelik	BM8H	0,5 - 2 t	\$	12,00
			2,5 - 5 t	\$	18,00
<b>HY-8-102</b> 	Çelik Alaşım Bilyalı Tartım Modülü	H8C	0,5 - 2 t	\$	15,00
			2,5 - 5 t	\$	20,00
<b>BY-8-104</b> 	Paslanmaz Çelik Bilyalı Tartım Modülü		0,5 - 2 t	\$	23,00
			2,5 - 5 t	\$	32,00
<b>DHM-8402</b> 	Çelik Alaşım Bağlantı Modülü		0,5 - 2 t	\$	
			3 - 5 t	\$	
<b>DBM-8402</b> 	Paslanmaz Çelik Bağlantı Modülü		0,5 - 2 t	\$	
			3 - 5 t	\$	
<b>BM14G</b> Alt ve Üst Bağlantı Modülleri	Paslanmaz Çelik		10,20,30 t	\$	
			50 t	\$	
<b>ZSFY</b> Alt ve Üst Bağlantı Modülleri	Çelik Alaşım		30 t	\$	
			50t	\$	

## BAĞLANTI KUTULARI

Model	Özellikler	Kapasite	FIYAT (TL)
<b>JB-46</b> 	Plastik	4 Kanal	<b>170,00</b>
	Toplama Kutusu (Junction Box) JB		
<b>JB-SS</b> 	Paslanmaz Çelik	4 Kanal	<b>260,00</b>
	Toplama Kutusu (Junction Box) JB	6 Kanal	<b>295,00</b>
<b>DJB-4SS</b> 	Paslanmaz Çelik	DJB-4 ( 4 port'lu)	<b>1.450,00</b>
	Toplama Kutusu ( Digital Junction Box) DJB	DJB-6 ( 6 port'lu)	<b>1.650,00</b>

## AKS KANTARI

Model	Kapasite	FIYAT (TL)
<b>AKS KANTARI (MOBİL)</b> 	<b>L15B</b> 15 t	<b>48.425,00</b>
<b>Özellikler :</b> Taşınabilir Aks Kantarı Önce ön iki teker, daha sonra arka iki teker tartılır Yazıcı		

**BASKÜL İLAVE PARÇALARI**

MODEL				FİYAT (TL)	
<b>SEHPALAR-A (Herkül Ayak)</b>					
Platform Ölçüsü	Yükseklik	Baskül'ün Kapasitesi	Tip	Elektro Statik Fırın Boyalı	Paslanmaz
40 x 50 cm	h = 50 cm	Max : 300 kg	<b>HERKÜL</b> 	680,00	-
50 x 60 cm				735,00	-
60 x 70 cm		760,00		-	
70 x 80 cm		985,00		-	
80 x 90 cm		1.035,00		-	
		Max : 600 kg			

<b>SEHPALAR-B (Sabit Profil Ayaklı)</b>					
Platform Ölçüsü	Yükseklik	Baskül'ün Kapasitesi	Tip	Elektro Statik Fırın Boyalı	Paslanmaz
40 x 50 cm	h = 50 cm	Max : 600 kg	<b>SABİT PROFİL AYAKLI</b> 	440,00	1.270,00
50 x 60 cm				470,00	1.360,00
60 x 70 cm				490,00	1.430,00
70 x 80 cm				570,00	1.615,00
80 x 90 cm				615,00	1.720,00
100 x 100 cm		Max : 600 kg		775,00	2.965,00
		Max : 1500 kg		800,00	3.125,00
120 x 120 cm		Max : 600 kg		915,00	4.155,00
		Max : 1500 kg		985,00	4.325,00
120 x 150 cm				1.205,00	5.240,00
120 x 200 cm				1.260,00	-
150 x 150 cm				1.320,00	5.840,00
150 x 200 cm				1.335,00	7.055,00
200 x 200 cm				1.465,00	-

\* Daha yüksek kapasiteler ve farklı boyutlar için fiyat isteyiniz.

<b>SEHPALAR-C (Portatif Profil Ayaklı)</b>					
Platform Ölçüsü	Yükseklik	Baskül'ün Kapasitesi	Tip	Elektro Statik Fırın Boyalı	Paslanmaz
70 x 80 cm	h = 50 cm	Max : 600 kg	<b>PORTATİF PROFİL AYAKLI</b> 	460,00	540,00
80 x 90 cm					

**BASKÜL İLAVE PARÇALARI**

MODEL				FİYAT (TL)	
<b>RAMPALAR</b>					
Rampa Boyutları				Elektro Statik Fırın Boyalı	Paslanmaz
60 x 70 cm				775,00	2.200,00
100 x 70 cm				900,00	2.405,00
120 x 70 cm				1.160,00	3.235,00
150 x 70 cm				1.280,00	3.515,00
170 x 70 cm				1.595,00	4.410,00
200 x 70 cm				1.990,00	5.105,00
100 x 100 cm				1.935,00	6.005,00

\* Farklı rampa boyutları için fiyat isteyiniz.

<b>BOYUNLAR</b>					
				Elektro Statik Fırın Boyalı	Paslanmaz
Seyyar Boyun	Sabit Ayaklı			320,00	
	Tekerlekli			475,00	

\* Farklı Seyyar Boyunlar için fiyat isteyiniz.

<b>AKSESUARLAR</b>					
				Elektro Statik Fırın Boyalı	Paslanmaz
İtme Kolu ve Tekerlek	80 x 90 platformlar için				-
	120 x 120 platformlar için				-

## BASKÜL TANIMLARI

### Tek Yük Hücreli Basküllerin Tanımlanma Sistemi

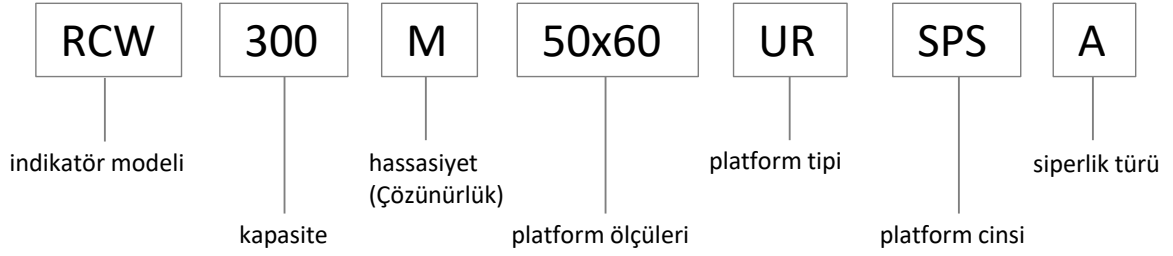

HASSASİYET	
<b>A</b>	: Onaylı 1/3.000
<b>L</b>	: 1 / 15.000
<b>M</b>	: 1 / 30.000
<b>H</b>	: 1 / 60.000
<b>S1</b>	: 1 / 100.000

PLATFORM TİPİ	
<b>1D</b>	: Tek Yük Hüc. Klasik Model
<b>U</b>	: Tek Yük Hüc. Eko Model
<b>UR</b>	: Tek Yük Hüc (Köşe Yuvarlak)
<b>LAR</b>	: Tek Yük Hüc Alümin Gövde
<b>LUR</b>	: Tek Yük Hüc Alümin Gövde

PLATFORM CİNSİ	
<b>B</b>	: Elektro Statik Fırın Boyalı
<b>S</b>	: Paslanmaz Tabla
<b>SBS</b>	: Paslanmaz Tabla, Boyalı Siperlik
<b>SPS</b>	: Paslanmaz Tabla, Paslanmaz Siperlik
<b>SX</b>	: Paslanmaz Gövde (Loadcell Alüminyum )
<b>SS</b>	: Paslanmaz Gövde ve Paslanmaz Load cell

### Dört Yük Hücreli Basküllerin Tanımlanma Sistemi

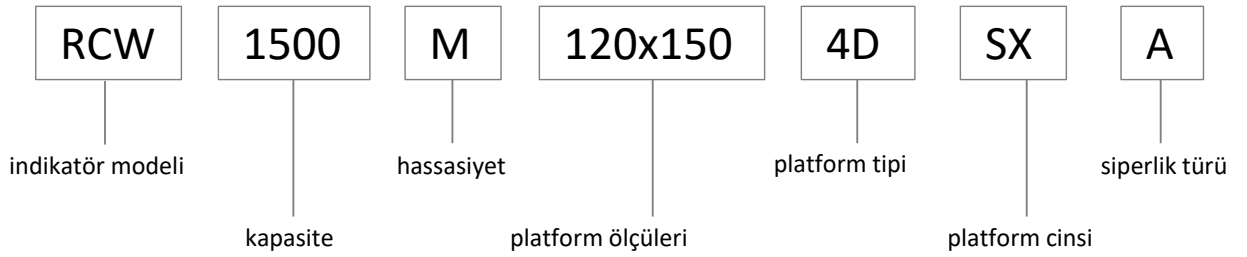

AĞIR ÇEKERLİ BASKÜL TİP TANIMLAMALARI ;	
<b>4D</b>	: Dört Yük Hücreli ve Çift Çerçevesi Platform
<b>4L</b>	: Dört Yük Hücreli ve Tek Çerçevesi Platform
<b>4MB</b>	: Dört Yük Hücreli ve Mono Blok Platform
<b>4SB</b>	: Dört Yük Hücreli ve Slim Blok Platform
<b>E</b>	: Elektromekanik Platform
<b>4U</b>	: Dört Yük Hücreli ve U-tipi Platform
<b>4BK</b>	: Dört Yük Hücreli ve U-tipi Platformlu Blok Kantarı
<b>LPDR</b>	: Dört Yük Hücreli ve alçak tabanlı , Kendinden Rampalı Platform
<b>LP</b>	: Dört Yük Hücreli ve Alçak tabanlı Platform
<b>4P</b>	: Dört Yük Hücreli ve Alçak Tabanlı Platform

PLATFORM CİNSİ	
<b>B</b>	: Elektro Statik Fırın Boyalı
<b>S</b>	: Paslanmaz Tabla
<b>SBS</b>	: Paslanmaz Tabla , Boyalı Siperlik
<b>SPS</b>	: Paslanmaz Tabla , Paslanmaz Siperlik
<b>SX</b>	: Paslanmaz Gövde (Load cell Alüminyum )
<b>SS</b>	: Paslanmaz Gövde ve Paslanmaz Load cell