



More information on the website
radwag.com/en/info,w1,H7B

Anti-Draft Chamber 153, Anti-Draft Chamber



Anti-Draft Chamber 153



Anti-Draft Chamber

The drawings, photos and graphics used are for illustrative purposes only.

Overview

The anti-draft chamber is intended for balances featuring a weighing pan 128×128 mm. It is an optional equipment for balances operating in unfavourable ambient conditions (air movement air drafts). It is installed as replacement of a standard pan draft shield. The anti-draft chamber features slidable top and side doors ensuring unbounded access to the weighing pan.

Compatible with

PS X2 Precision Balance
PS R1 Precision Balance
PS R2 Precision Balance

WLC X2 Precision Balance
PS X2 Balances for PGC

Device dimensions

Anti-Draft Chamber 153, Anti-Draft Chamber

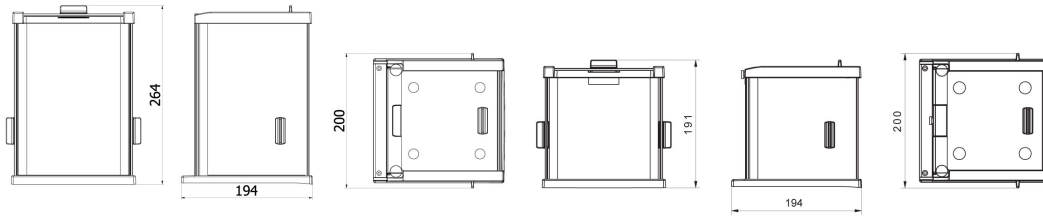

[Anti-draft chamber for balances with 128x128 mm weighing pan](#)

[Anti-draft chamber for X2 and R2 precision balances](#)

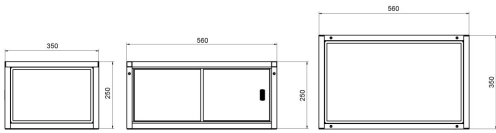

[Anti-draft chamber for microbalances](#)

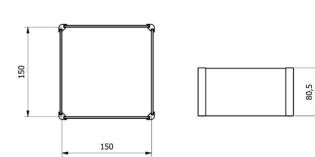

[Draft shield for precision balances](#)

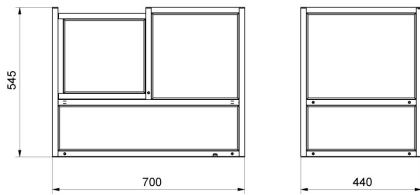

[Anti-draft chamber for APP-00-SK mass comparators](#)

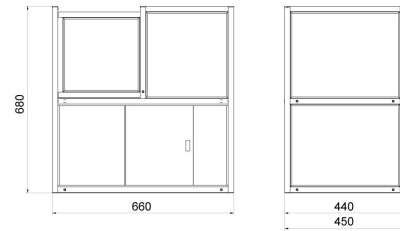

[Anti-draft chamber for APP-KO-SK mass comparators](#)

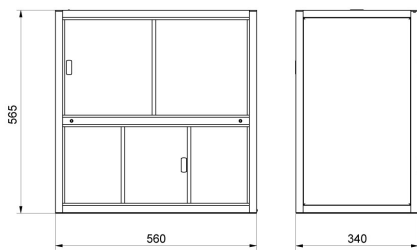

[Anti-draft chamber for WAY-KO-SK mass comparators](#)

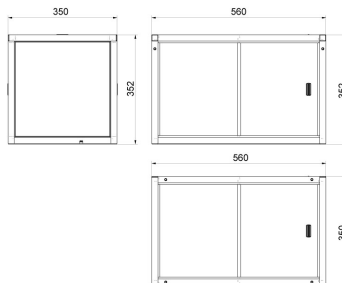

[Anti-draft chamber for XA 4Y / XA 4Y PLUS balances](#)

Anti-Draft Chamber 153

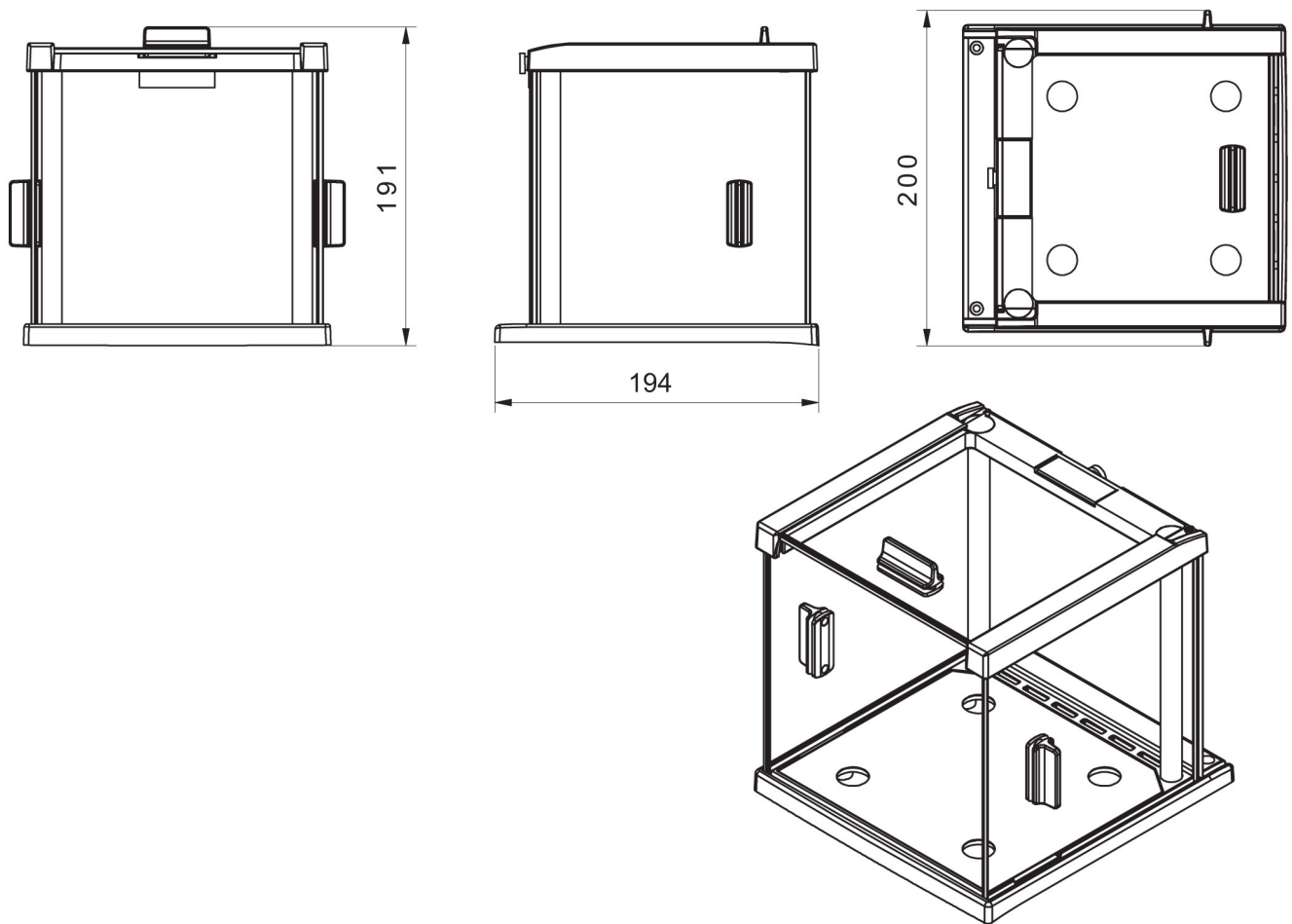

Anti-Draft Chamber

